



Lighting

LUCAS head lights, rear lamps and side lamps. Classic car fog and spot lamps.

Drivers don't tend to pay much attention to the lights on their cars unless, of course, they're failing. That's why it's essential to install lights onto a classic car that are hard-wearing, reliable and don't require a second thought once you've hit the road.

From headlights to warning lights, we stock as many original LUCAS lighting products as possible, several of which we own the original tooling for and manufacture on-site. When an original product is unavailable, we source the best available option or offer a good alternative from other companies such as Wipac.

Replacing your light units can be a daunting task. To make it easier for you, please get in touch with our sales team by phone or email for recommendations on what was original to your car or what we recommend as an alternative. We also have freely available technical videos on YouTube.

MOTORCYCLE HEADLAMPS



6 1/2" LIGHT UNIT

Complete with main and pilot bulbholders. You will need to order the bulbs separately, for the main refer to [LLB414](#) and for the pilot refer to [LLB233](#)

010.592



8" LIGHT UNIT

Complete with main and pilot bulbholders. You will need to order the bulbs separately, for the main refer to [LLB414](#) and for the pilot refer to [LLB233](#)

010.593



4 1/4" HEADLAMP

Base mounted by 10mm bolt. Diameter 108mm. Depth front to rear 130mm. Fitted with 12v Halogen bulb 60/55 watts and 'E' marked. With sidelight

010.502



5" HEADLAMP SIDE MOUNTING

5" is nominal size of lens. Dimension over side mounting points is 147 mm. Depth front to rear 100 mm. 12 volt 35/35 watts. There are two holes at the rear, for suitable Grommets refer to [080.085](#). For a spare Bulb refer to [LLB3604](#)

010.518



REPRO LUCAS 7" HEADLAMP

[SS700P](#) reproduction, complete with light unit, panel, switch and ammeter. Black enamel shell with chrome rim

010.526



7" HEADLAMP

Side mounting with chrome finish

010.503



7" HEADLAMP VISOR

To suit 7 in diameter headlamps. No drilling, fits under rim. Chromed

010.517



5 3/4" BATES HEADLAMP VISOR

Headlamp Visor to suit 5 3/4 in diameter headlamp. Fits under rim, no drilling. Sold singly.

010.501

LIGHTING

SWITCHES

IGNITION

WIRING

HEATERS & ELECTRIC FANS

ACCESSORIES

BODY HARDWARE

BRAKES & SUSPENSION

CLUTCH KITS

EXHAUSTS

FIXINGS

FUEL SYSTEMS & FILTERS

GAUGES

MIRRORS

POWER STEERING

SEATS & SEAT BELTS

WASHERS & WIPERS

OIL & AIR FILTERS

CARE & STORAGE

OIL, GREASE & FLUIDS

PAINT & ANTI-RUST

TOOLS

At 7¾" (197mm) these were slightly larger than the standard headlamps fitted to most cars of the day, and were fitted to the luxury end of the market. They incorporated either a LUCAS tri-bar design, or **Rolls-Royce** and **Bentley's** own emblems. The distinguishing features of these units were their fluted silver on brass reflectors and flat plain glass lens. For this reason we don't recommend changing the bulbs to any other type. There were two versions which we are calling 'Early' & 'Late'. The rim of the 'Early' backshell was turned inwards and that of the 'Late' backshell was turned outwards.



LIGHT UNIT
A very high quality reproduction of the 7.7 inch PF770 Headlamp light unit
010.192



LIGHT UNIT
For 'Early' PF770 headlamps with Bentley logo on centre bar
010.191



BULB ADAPTOR
Use with PF770 light units and bulbholder 54933718
553480

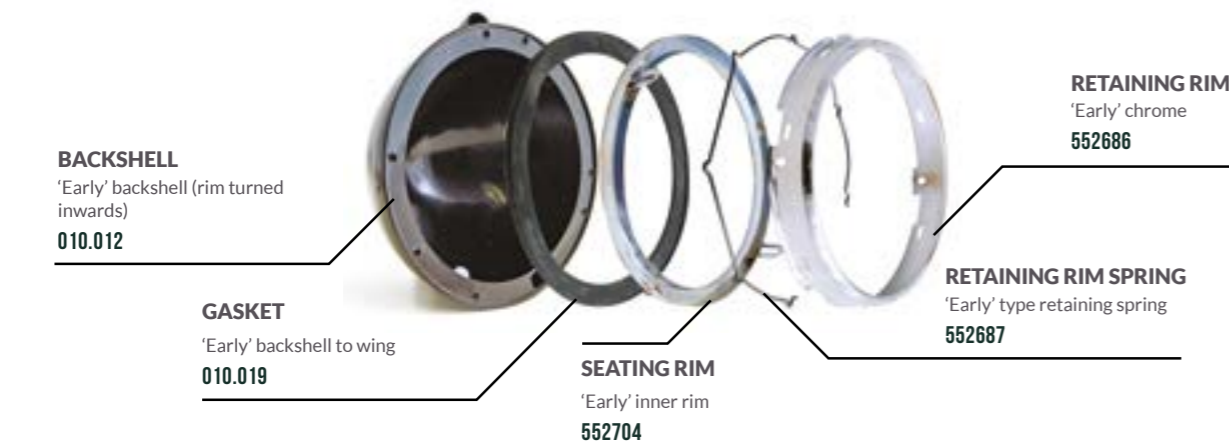

BACKSHELL
'Early' backshell (rim turned inwards)
010.012

GASKET
'Early' backshell to wing
010.019

SEATING RIM
'Early' inner rim
552704

RETAINING RIM SPRING
'Early' type retaining spring
552687

RETAINING RIM
'Early' chrome
552686



FIXING KIT
'Early' type for two lamps
010.017



BPF MAIN/DIP BULBHOLDER
For BPF type bulb. Complete with wiring harness
54933718



BRACKET
Reproduction chrome bracket with two rim screws as fitted to **Aston, Jaguar** etc.
010.334



SCREW
Chromed screw for 010.334
010.355

UPGRADE TO HALOGEN 7"

To upgrade to a modern Halogen 7" light unit replace the following:
552686 replace by 010.490
54933718 replace by 010.161 or 010.338
Spring 552687 is discarded
Select Halogen 7" light unit to suit your own requirements



010.161
HALOGEN BULBHOLDER
Halogen main/dip
010.161
Halogen main/dip, ceramic
010.338



RETAINING RIM
010.492



ADAPTER RIM
010.493

The 'J Light', as fitted on **Jaguars** from late 1950s to 1970s, without sidelight



'J LIGHT' LIGHT UNIT
As supplied by us it can be fitted with a UEC bulb or H4 Halogen bulb **LLB012**. This is a quality reproduction
J700/R



DUST SEAL
Jaguar XK140/150 Light Unit Dust Seal
010.3001



GASKET
'Late' backshell to wing
010.197

BACKSHELL
'Late' backshell (rim turned outwards)
010.014

INNER SEATING RIM
Specially for J700 light unit in 'Late' type backshell
554907

CHROME RIM
Screw fitting, chrome on copper for **Jaguar XK140, XK150**, 227mm external diameter
554903/R

RETAINING RIM
Specially for **J700** light unit in 'Late' type backshell
554906

PF770 HEADLAMP PARTS (LATE)



GASKET
'Late' backshell to wing
010.197



SEATING RIM
'Late' inner rim
010.016



LIGHT UNIT
For 'Early' PF770 headlamps with Bentley logo on centre bar
010.191



BULB ADAPTOR
Use with PF770 light units and bulbholder 54933718
553480



SCREW KIT
3 screws, springs and covers
60600614



BULBHOLDER
'Push & twist' bulbholder for BPF type headlamps. This item has 3 spade type terminals on the rear, and can be used either with a harness plug or a pre-wired headlamp harness. This can also be used on PF770 lamps in conjunction with a bulb adaptor.
554691

LIGHTING

SWITCHES

IGNITION

WIRING

HEATERS & ELECTRIC FANS

ACCESSORIES

BODY HARDWARE

BRAKES & SUSPENSION

CLUTCH KITS

EXHAUSTS

FIXINGS

FUEL SYSTEMS & FILTERS

GAUGES

MIRRORS

POWER STEERING

SEATS & SEAT BELTS

WASHERS & WIPERS

OIL & AIR FILTERS

CARE & STORAGE

OIL, GREASE & FLUIDS

PAINT & ANTI-RUST

TOOLS

LIGHTING

SWITCHES

IGNITION

WIRING

HEATERS & ELECTRIC FANS

ACCESSORIES

BODY HARDWARE

BRAKES & SUSPENSION

CLUTCH KITS

EXHAUSTS

FIXINGS

FUEL SYSTEMS & FILTERS

GAUGES

MIRRORS

POWER STEERING

SEATS & SEAT BELTS

WASHERS & WIPERS

OIL & AIR FILTERS

CARE & STORAGE

OIL, GREASE & FLUIDS

PAINT & ANTI-RUST

TOOLS

We suggest that before you select parts from this page you determine whether your LUCAS 7" lamps are of the 3-adjuster or 2-adjuster type. The early LUCAS 7" headlamps were fitted with three adjusters for aiming the light beam for which we can supply the following spare parts:

The later LUCAS 7" headlamps were fitted with only two adjusters for aiming the light beam for which we can supply the following spare parts:

LIGHTING

SWITCHES

IGNITION

WIRING

HEATERS & ELECTRIC FANS

ACCESSORIES

BODY HARDWARE

BRAKES & SUSPENSION

CLUTCH KITS

EXHAUSTS

FIXINGS

FUEL SYSTEMS & FILTERS

GAUGES

MIRRORS

POWER STEERING

SEATS & SEAT BELTS

WASHERS & WIPERS

OIL & AIR FILTERS

CARE & STORAGE

OIL, GREASE & FLUIDS

PAINT & ANTI-RUST

TOOLS

LIGHTING

SWITCHES

IGNITION

WIRING

HEATERS & ELECTRIC FANS

ACCESSORIES

BODY HARDWARE

BRAKES & SUSPENSION

CLUTCH KITS

EXHAUSTS

FIXINGS

FUEL SYSTEMS & FILTERS

GAUGES

MIRRORS

POWER STEERING

SEATS & SEAT BELTS

WASHERS & WIPERS

OIL & AIR FILTERS

CARE & STORAGE

OIL, GREASE & FLUIDS

PAINT & ANTI-RUST

TOOLS

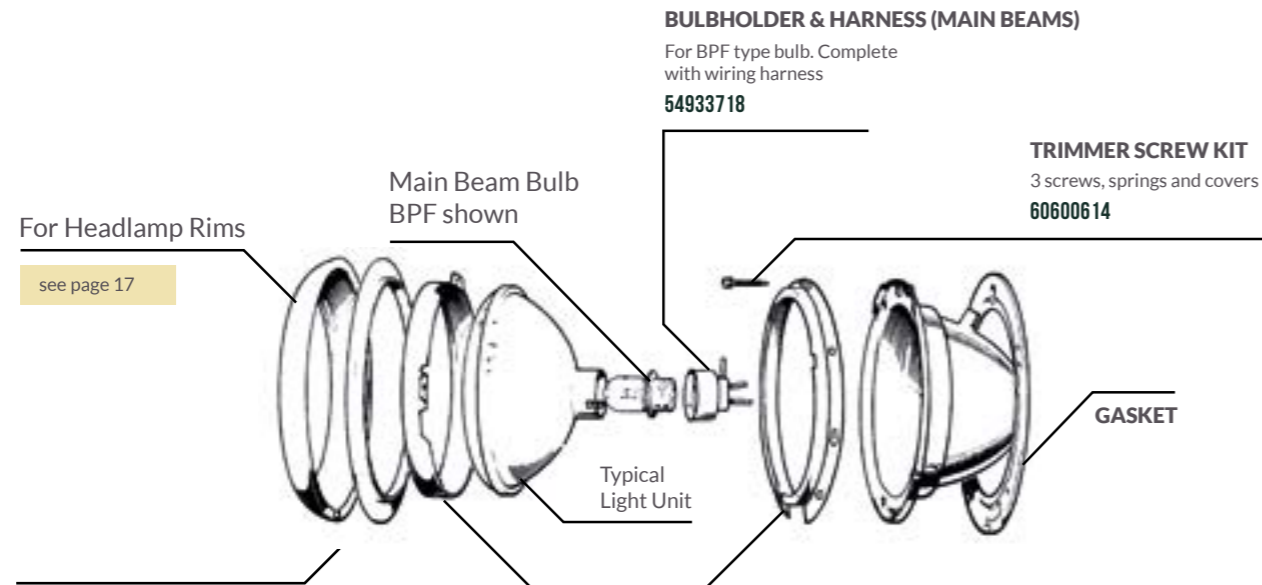

DUST EXCLUDER
Made of rubber, it fits under the headlamp rim to keep out the dust. (Fits most 7" headlamps)
552906

RETAINING RIM SET
Chromed retaining rim and seating rim. Part No. covers two parts
554872

LUCAS 3 ADJUSTER BACKSHELL KIT
LUCAS 3 Adjuster Backshell Kit for 7" lamps
DA3208LUCAS



GASKET
Made of rubber, it fits between the backshell and the wing. 29mm wide
554279



DUST EXCLUDER
Made of rubber, it fits under the headlamp rim to keep out the dust. (Fits most 7" headlamps)
552906



RETAINING RIM SET
Chromed retaining rim and seating rim. Part No. covers two parts
554872



BPF MAIN/DIP BULBHOLDER
For BPF type bulb. Complete with wiring harness
54933718



STEEL BACKSHELL
Just the backshell
54522954



BPF SIDELIGHT
Bulbholder for the sidelight bulb on BPF headlamps
554710



SCREW KIT
3 screws, springs and covers
60600614



BULB HOLDER FOR BPF BULBS
Bulb Holder For BPF Bulbs
010.499

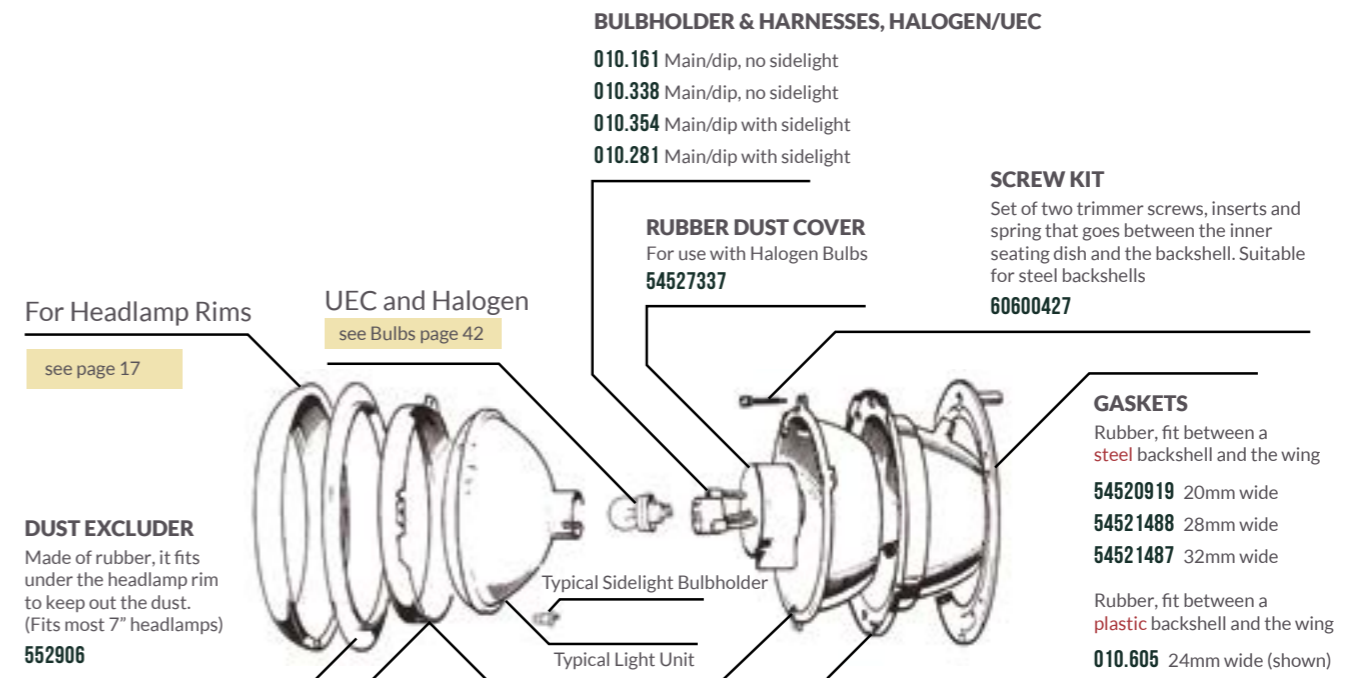

RETAINING RIM
Chromed retaining rim (Part of 54058414)
54521913

RETAINING RIM SET
Chromed retaining rim and inner seating dish. Part No. covers two parts. Inner seating dish is moulded plastic
54058414

STEEL BACKSHELL
Just the backshell
54522342

PLASTIC BACKSHELL
Supplied with retaining rim and fittings as shown. Takes outer rim secured with a screw
010.599



LUCAS STYLE PLASTIC BACKSHELL
LUCAS Style 7" 2 Adjuster Backshell - Plastic
010.002



LUCAS STYLE PLASTIC BACKSHELL WITH GASKET
LUCAS Style 7" Backshell Assembly - 2 Adjuster - Plastic. Comes complete with back gasket.
010.048



DUST EXCLUDER
Made of rubber, it fits under the headlamp rim to keep out the dust. (Fits most 7" headlamps)
552906



RETAINING RIM
Chromed retaining rim (Part of 54058414)
54521913



SEATING RIM
Headlamp seating rim for a Jaguar E-Type Series 1
010.741



RETAINING RIM SET
Chromed retaining rim and inner seating dish. Part No. covers two parts. Inner seating dish is moulded plastic
54058414



SCREW KIT
Set of two trimmer screws, inserts and spring that goes between the inner seating dish and the backshell. Suitable for steel backshells
60600427



JAGUAR BACKSHELL
Special Backshell for Jaguar E Type Series S1
54520553



STEEL BACKSHELL
Just the backshell
54522342



PLASTIC BACKSHELL
Supplied with retaining rim and fittings as shown. Takes outer rim secured with a screw
010.599
010.579 Clip for push on rims

For the new post-war models, LUCAS designed a flush-fitting headlamp and set about persuading car makers to use it. The first car to do so was the 'raised headlamp' **Morris Minor** in 1949/50. As it was about 7 inches in diameter it became known as the "7 inch Headlamp". It consisted of a lens/reflector unit with a replaceable pre-focused tungsten double filament bulb (British Pre-Focus or BPF for short). The double filament bulb gave the welcome safety feature of the driver being able to dip the beam to prevent dazzling oncoming traffic. To start with, the reflectors were silver plated onto brass, but by 1950 the reflective surface was an aluminium coating onto steel which was cheaper and gave a much better light. The lens was also developed using a system of small prisms, improving the shapes of both the main and dipped beams. The BPF headlamp was fitted until 1963. LUCAS used RHD to indicate both Right Hand Drive and Right Hand Dip. For clarity on these pages we are using 'dips to the left' and 'dips to the right' as appropriate

LIGHTING

SWITCHES

IGNITION

WIRING

HEATERS & ELECTRIC FANS

ACCESSORIES

BODY HARDWARE

BRAKES & SUSPENSION

CLUTCH KITS

EXHAUSTS

FIXINGS

FUEL SYSTEMS & FILTERS

GAUGES

MIRRORS

POWER STEERING

SEATS & SEAT BELTS

WASHERS & WIPERS

OIL & AIR FILTERS

CARE & STORAGE

OIL, GREASE & FLUIDS

PAINT & ANTI-RUST

TOOLS



STANDARD BPF LIGHT UNIT (RHD)

This light unit, without sidelight, and with 'LUCAS' on the centre of the glass is still available. Dips to the left
LUB300



LIGHT UNIT WITH SIDELIGHT (RHD)

Quality reproduction replacing the LUCAS original on motorcycle SS700P headlamps and many car applications. Vertical dip
516798/R



P700 TRIPOD LIGHT UNIT (RHD)

Although LUCAS tried to keep things standard, some "specials" were produced, one of which was the light unit shown above. Dips to the left
P700/R



BPF LIGHT UNIT WITH SIDELIGHT

Standard BPF (British Pre-Focus) as fitted from 1945 to 1963 Right Hand Drive with sidelight. Dips to the left
LUB365

For bpf bulbs see page 41-42

7" UEC LIGHT UNITS

The dipped beam of the sealed beam unit was asymmetrical and in 1964 an international working party proved conclusively that the asymmetric beam was preferable to the continental flat cut off which did not provide enough light in the dipped position for the driver to see properly. All countries agreed to change over to the asymmetric beam, but instead of going over to the British/American way of achieving this, the continental lighting firms continued with a modification of their shielded bulb method of control. This resulted in the 'unified' or UEC method with a new bulb and cap that could not be used in any other type of headlamp. However, it was still 7" in diameter, and when this new UEC standard was established, LUCAS started making these headlamps and they were fitted through to the 1970s

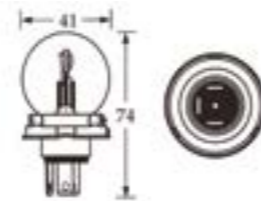

PL700 TRIPOD LIGHT UNIT
A LUCAS "special". Quality reproduction LHD without sidelight - Dips to the right
54520293



PL700 TRIPOD LIGHT UNIT
LUCAS PL Tripod Light with 'LUCAS PL' in the centre, as fitted from late 1950's to 1970s. Right Hand Drive. A Left Hand Drive version is also available
556599

Depending on the model of your car you may need a new lamp wiring harness:



HARNESSES

010.161 Provides wiring for main/dip only. Also for UEC lamps
010.338 As above but ceramic with short 100mm leads
If you use the sidelight you will need to wire the sidelight separately using Lucar 6.4mm (1/4") connectors



SIDELIGHT BULB
12 volt 4 watts
LLB233



SIDELIGHT BULB
12 volt 5 watts
LLB501



HARNESSES

010.281

This provides wiring for main/dip and sidelight. Discard the sidelight bulbholder that comes with the light unit. Order sidelight bulb LLB501 separately

THE TRUTH ABOUT SEALED BEAM LIGHT UNITS



SCAN ME



<https://youtu.be/XkiFJJIKVpk>

1963 saw the introduction of the sealed beam light unit, brought in to replace the BPF bulb type units. They were basically a big bulb and once they blew you had to replace the whole unit. There was a much better light output from these compared to the BPF and they stayed in use until the mid 70s. We currently offer both right hand drive and left hand drive both with side light facility



SEALED BEAMS

010.498 LHD-with sidelight window. Dips to the right
010.497 RHD-with sidelight window. Dips to the left

HALOGEN LIGHT UNITS

The lighting manufacturers were trying their best to get more light out of the headlamp and onto the road, especially on dipped beam, and LUCAS believed that the optimum was their 75 watt sealed beam unit, this being the maximum permitted in Britain. However, when the halogen light source was introduced from America all the difficulties in effecting further improvement were solved at a stroke as halogen gave twice the light for the same amount of power consumed, and even though car manufacturers were now starting to move away from the 7" headlamp, firstly to two smaller units, then to individually styled shapes, LUCAS added halogen to their range of 7" headlamps. The bulb used is the Halogen H4 which is 60/55 watts. We offer a selection of halogen light units, from LUCAS, Wipac, Cibie and others



HALOGEN HEADLAMP ASSEMBLIES

Main and dip beams with sidelight, metal reflectors, plastic backshell, gasket and wiring harness. Fitted with 12 volt halogen bulb 60/65 watts and 5 watt sidelight bulb. E Marked

010.265 RHD-Dips to the left

010.266 LHD-Dips to the right

010.700 RHD-Dips to the left, with plastic reflector

010.100 As **010.700** but with chrome rim as fitted to **Mini**

As above, but with half plastic mounting rim instead of full backshell. As fitted to **Land Rovers**

010.701 RHD-Dips to the left. No sidelight

010.702 LHD-Dips to the right, No sidelight

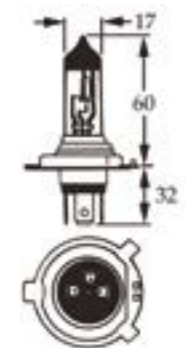

H4 HALOGEN BULB
12 volt 60/55 watts
LLB472

LIGHTING

SWITCHES

IGNITION

WIRING

HEATERS & ELECTRIC FANS

ACCESSORIES

BODY HARDWARE

BRAKES & SUSPENSION

CLUTCH KITS

EXHAUSTS

FIXINGS

FUEL SYSTEMS & FILTERS

GAUGES

MIRRORS

POWER STEERING

SEATS & SEAT BELTS

WASHERS & WIPERS

OIL & AIR FILTERS

CARE & STORAGE

OIL, GREASE & FLUIDS

PAINT & ANTI-RUST

TOOLS

- LIGHTING
- SWITCHES
- IGNITION
- WIRING
- HEATERS & ELECTRIC FANS
- ACCESSORIES
- BODY HARDWARE
- BRAKES & SUSPENSION
- CLUTCH KITS
- EXHAUSTS
- FIXINGS
- FUEL SYSTEMS & FILTERS
- GAUGES
- MIRRORS
- POWER STEERING
- SEATS & SEAT BELTS
- WASHERS & WIPERS
- OIL & AIR FILTERS
- CARE & STORAGE
- OIL, GREASE & FLUIDS
- PAINT & ANTI-RUST
- TOOLS

- LIGHTING
- SWITCHES
- IGNITION
- WIRING
- HEATERS & ELECTRIC FANS
- ACCESSORIES
- BODY HARDWARE
- BRAKES & SUSPENSION
- CLUTCH KITS
- EXHAUSTS
- FIXINGS
- FUEL SYSTEMS & FILTERS
- GAUGES
- MIRRORS
- POWER STEERING
- SEATS & SEAT BELTS
- WASHERS & WIPERS
- OIL & AIR FILTERS
- CARE & STORAGE
- OIL, GREASE & FLUIDS
- PAINT & ANTI-RUST
- TOOLS



WIPAC HALOGEN LIGHTING SETS

A pair of halogen light units (slightly domed) with 12 volt 60w/55w halogen bulbs, retaining springs, sidelight bulbholders and bulbs (where applicable). E Marked

- 010.006** RHD-without sidelight. Dips to the left
- 010.007** RHD-with sidelight. Dips to the left (shown)
- 010.008** LHD-without sidelight. Dips to the right
- 010.009** LHD-with sidelight. Dips to the right



LUCAS LIGHT UNIT SETS

RHD-With provision for sidelight. Domed lens. E marked. Complete with two 12 volt halogen bulbs **LLB472** and dust covers.

- Dips to the left, (shown)
- LUB801**
- For **LUB801** use bulbholder **010.142** or **010.285** and sidelight bulb **LLB233**



7" TRIPOD LIGHT UNIT HALOGEN WITH SIDELIGHT P700 REPLACEMENT

Reproduction of the LUCAS P700 fitted for an H4 Halogen bulb (**LLB472**, sold separately). New connector or harness to suit the Halogen bulb is required to fit this. A suitable wiring harness would part number **010.161**.



This light unit also has a sidelight and comes complete with a sidelight bulb and two wires to connect it

- P700/H** 7" Right Hand Drive Tripod light unit.
- P700/HL** 7" Left Hand Drive Tripod light unit.



UEC TRIPOD LIGHT UNITS

H4 version of the **PL700**
LHD-with sidelight. Dips to the right
54520293H4



HALOGEN MAIN/DIP SOCKET

For use with halogen bulbs. For you to wire up
010.081 Straight type



DUST COVER

For halogen light units. Made of rubber, it fits over halogen bulbs to keep out dust
54527337



7" STONEGUARDS

Secure using the clips supplied which fit under the rim. No drilling
010.373 Chrome plated

VERTICAL DIP (RHD OR LHD) WITHOUT SIDELIGHT



010.731

Make on Lens	Lens	Reflector	Part No.	Uses Main/Dip Bulb	Dust Cover
-	Flat/Tripod	Fluted	010.731	LLB472 (included)	Included

MAIN BEAM ONLY WITHOUT SIDELIGHT



010.494

Make on Lens	Lens	Reflector	Part No.	Uses Main/Dip Bulb	Dust Cover
-	Flat	Metal	010.494	LLB453	54527337

RIGHT HAND DRIVE (DIPS TO THE LEFT) WITH SIDELIGHT



010.487

010.044

010.256

010.177

Make on Lens	Lens	Reflector	Part No.	Uses Main / Dip Bulb	Sidelight Bulbholder	Sidelight Bulb	Dust Cover
Wipac	Slightly domed	Plastic	010.487	LLB472	010.285	LLB233	54527337
Wipac	Slightly domed	Metal	010.044	LLB472	010.088	LLB501	54527337
Wipac	Polycarbonate	Plastic	010.256	LLB472	010.285	LLB233	54527337
Hella	Slightly domed	Metal	010.177	LLB472	Included	LLB233	Included



WIPAC 7" LED HEADLAMP WITH HALO

Fits all vehicles that have standard 7" headlights

Designed to replace any existing 7" headlight - for example, Land Rover Defender, Classic Mini, and many classic vehicles. These headlights are exclusively designed and manufactured by Wipac and are branded on each lens. The quality of these LED headlights is unrivaled and Wipac has invested heavily in time and components to ensure that these are the best on the market.

These Headlights are to be fitted in our 2 adjusters 7-inch backshell - Part number **010.599**. (see page 15). These are shown on the left but not included with the light units.

- 010.630** 7 Inch Left Hand Drive - Dips to the Right - Sold as a Pair
- 010.629** 7 Inch Right Hand Drive - Dips to the Left - Sold as a Pair



Unless listed as included, you need to order the Bulbs, Bulbholders and Dust Covers separately

**FOR HALOGEN BULBS SEE PAGE 46,
FOR OTHER BULBS SEE PAGE 42 - 46**

7" HALOGEN LIGHT UNITS

RIGHT HAND DRIVE (DIPS TO THE LEFT) WITHOUT SIDELIGHT



010.157



010.486

Make on Lens	Lens	Reflector	Part No.	Uses Main/Dip Bulb	Dust Cover
Wipac	Slightly domed	Metal	010.157	LLB472	54527337
Wipac	Slightly domed	Plastic	010.486*	LLB472	54527337

* WIPAC **010.486** E Marked. Plastic reflector. Made for the original *Mini*, also *Land Rover* and *Morgan*

LEFT HAND DRIVE (DIPS TO THE RIGHT)



Make on Lens	Sidelight	Lens	Reflector	Part No.	Uses Main/Dip Bulb	Sidelight Bulbholder	Sidelight Bulb	Dust Cover
Wipac	No	Slightly domed	Plastic	010.488	LLB472	-	-	54527337
Wipac	No	Slightly domed	Metal	010.158	LLB472	-	-	54527337
Wipac	Yes	Slightly domed	Plastic	010.489	LLB472	010.285	LLB233	54527337
Wipac	Yes	Slightly domed	Metal	010.159	LLB472	010.088	LLB501	54527337
Hella	Yes	-	Metal	010.1058	LLB472	-	LLB233	-
Hella	No	-	Metal	010.1059	LLB472	-	-	-



HARNESSES

010.161 Halogen main/dip and no sidelight. Also for UEC lamps
010.338 As above but ceramic with short 100mm leads
 If you use the sidelight you will need to wire the sidelight separately using Lucar 6.4mm (1/4") connectors



HARNESSES

010.281 For 7" Halogen light units with plastic reflector and main/dip and sidelight. Includes Wipac with plastic reflector and Cibie (replaces the supplied sidelight bulbholder). Uses sidelight bulb LLB501



PLASTIC BACKSHELL

Supplied with retaining rim and fittings as shown. Takes outer rim secured with a screw includes back gasket 28.5mm wide
010.599



SIDELIGHT BULBHOLDER

For use with halogen headlamps. Takes bulb LLB233
010.285



SIDELIGHT BULBHOLDER

Bulbholder, push fit into 14mm diameter hole. Takes capless bulb LLB501
010.088



HEADLAMP PILOT BULBHOLDER

5 3/4" or 7" Headlamp Pilot Bulbholder BA9 Bayonet. For sidelight/pilot bulb on BPF Headlamps. Uses LLB989 or LLB951
554710



CHROME RIM* - PF770

Screw fitting, chrome on copper for Aston Martin 227mm external diameter
553978/R



CHROME RIM* - PF770

Chrome on copper for Jaguar XK120, screw fitting, 219mm external diameter
553620/R



CHROME RIM* - PF770

Screw fitting, chrome on copper for Jaguar XK140, XK150, 227mm external diameter
554903/R

*Please note that motifs and brackets (010.334) are not included with the above rims



ALUMINIUM RIM

Reproduction for Ford Cortina Mk I
010.333



CHROME RIM

Screw fitting for Rover P4, MG TF, MGA etc. 203mm external diameter
54520651/R



CHROME RIM

For MGB, Jaguar E Type, 206mm external diameter. Uses spring type rim catch
54521224/R



CHROME RIM

Triumph TR's, Spitfire's and Darts. 212mm external diameter. retained by clip on inside of rim
54520073



CHROME RIM

Screw fitting for Mini, Morris Minor, Morgan etc. 212mm external diameter. Screw included
54520650/R



CHROME RIM

Screw fitting for Austin Healey 3000 215mm external diameter
54522515/R



BRACKET

Reproduction chrome bracket as fitted to Aston, Jaguar etc.
010.334



SCREW

Chromed screw for 010.334
010.355



RIM SCREW

Chromed round headed screw used on some of these rims
010.604

Some cars were fitted with a special rim catch:



RIM CATCH

Used to secure the chrome rim on headlamps on MGBs etc. Known as the 'spring type' catch
010.188



RIM CATCH

Used to secure the chrome rim on headlamps on TRs
010.135



RIM CATCH

Screw type rim catch for 2 & 3 adjusting screw shells, but not plastic backshells
54522949



RIM CLIP

Clip used on push on rims with Plastic Backshell 010.599
010.579

Unless listed as included, you need to order the Bulbs, Bulbholders and Dust Covers separately

FOR HALOGEN BULBS SEE PAGE 46, FOR OTHER BULBS SEE PAGE 42 - 46

LIGHTING
SWITCHES
IGNITION
WIRING
HEATERS & ELECTRIC FANS
ACCESSORIES
BODY HARDWARE
BRAKES & SUSPENSION
CLUTCH KITS
EXHAUSTS
FIXINGS
FUEL SYSTEMS & FILTERS
GAUGES
MIRRORS
POWER STEERING
SEATS & SEAT BELTS
WASHERS & WIPERS
OIL & AIR FILTERS
CARE & STORAGE
OIL, GREASE & FLUIDS
PAINT & ANTI-RUST
TOOLS

LIGHTING
SWITCHES
IGNITION
WIRING
HEATERS & ELECTRIC FANS
ACCESSORIES
BODY HARDWARE
BRAKES & SUSPENSION
CLUTCH KITS
EXHAUSTS
FIXINGS
FUEL SYSTEMS & FILTERS
GAUGES
MIRRORS
POWER STEERING
SEATS & SEAT BELTS
WASHERS & WIPERS
OIL & AIR FILTERS
CARE & STORAGE
OIL, GREASE & FLUIDS
PAINT & ANTI-RUST
TOOLS



TRIPOD
Lens pattern for 010.730
Fluted reflector
010.730



SEALED BEAM
Head light unit 5 3/4" 12 volts
010.732 010.289
010.613 JLM216



HELLA
Hella 5 3/4" halogen left hand drive light unit
010.1060



HELLA
Hella 5 3/4" halogen right hand drive light unit. Main, dip and side light. Takes LLB472 H4 bulb (not supplied)
010.178



HELLA
Hella 5 3/4" halogen main beam light unit
010.1061



Make on Lens	Inner/Outer	Drive	Dips	Sidelight	Lens	Part No.	Uses Main/Dip Bulb	Sidelight Bulbholder	Sidelight Bulb
LUCAS	Inner	RHD/LHD	-	No	Almost Flat	LUB222	LLB472	-	-
LUCAS	Outer	RHD	Left	No	Almost Flat	LUB223	LLB472	-	-
LUCAS	Outer	LHD	Right	No	Almost Flat	LUB226	LLB472	-	-
-	Outer	RHD/LHD	Vertical	No	Domed/Tripod	010.730	LLB472	-	-
Neolite	Outer	RHD	Left	Yes	Almost Flat	010.591	LLB472	Included	Included
Neolite	Outer	LHD	Right	Yes	Slightly Domed	010.343	LLB472	Included	LLB233
-	Outer	RHD	Left	No	Domed	010.732	-	-	-
-	Outer	RHD	Left	No	Domed	010.613	-	-	-
-	Inner	RHD/LHD	No	No	Domed	010.289	-	-	-
Phillips		LHD	Right		Domed	JLM216			
Hella	Outer	RHD	Left	Yes	Flat	010.178	LLB472	Included	
Hella	Inner	RHD/LHD	No	No	Flat	010.1061	LLB448	-	-
Hella	Outer	LHD	Right	Yes	Flat	010.1060	LLB472	Included	

Unless listed as included, you need to order the Bulbs and Bulbholders separately.

FOR HALOGEN BULBS SEE PAGE 46



O.E. Specification freestanding 5 3/4" diameter headlamp pictured at Bromyard Speed Festival, on tour at Shelsley Walsh Hill Climb



5 3/4" HEADLAMP

O.E. Specification freestanding 5 3/4" diameter headlamp complete with light unit and H4 bulb and wiring harness. RHD - dips to the left

Black painted finish (left) **010.261**
Polished stainless steel finish (right) **010.262**



O.E. Specification freestanding 5 3/4" diameter headlamp, (as pictured above)



7" HEADLAMP

Polished steel freestanding headlamp, complete with RHD halogen light unit and bulb
010.257



7" HEADLAMP SHELL

Freestanding 7" Headlamp shell and Rim. Used as original equipment on various Lotus 7 type cars. Supplied without light unit to enable you to make your own choice of light unit from pages 10 - 13. Chrome finish
010.052



7" HEADLAMP SHELL

Freestanding 7" Headlamp Shell and Rim. Black Powder Coated
010.056



RETAINING RIM
LUCAS 5 3/4" Retaining Rim
54524588



LAMP MOUNTING SET
Incorporating plastic backshell and chromed steel retaining rim for 5 3/4" light units
010.243



OUTER MAIN/DIP HALOGEN WIPAC
Headlamp with sidelight, metal reflector, plastic backshell, bulbs and wiring
010.710



HEADLAMP VISOR
Bates headlamp visor to suit 5 3/4" diameter headlamps. Fits under rim, no drilling
010.501



STONEGUARDS
For protecting 5 3/4" headlamps. Secured using the clips supplied which fit under the rim. Chrome plated, no drilling
010.003

MEDALLIONS

As used on LUCAS freestanding headlamps

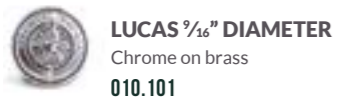

LUCAS 7/16" DIAMETER
Chrome on brass
010.101



LUCAS RED DOT MEDALLION FOR 1130 SIDELAMPS
574874



LUCAS 7/8" DIAMETER
Chrome on brass
010..103



RED TELL-TALES & CLIP

Made on the original tooling these red tell-tales with detailed LUCAS lettering, were used with sidelamps on Jaguar and other cars

573449
571888 Clip for red tell-tales



RIM CATCH

Used to secure the chrome rim 553248/R on LUCAS freestanding headlamps

534296



EARLY BULBHOLDER

Single contact takes bulbs LLB002, LLB003, LLB90, LLB057

010.395



EARLY BULBHOLDER

Double contact takes bulbs LLB170, LLB171

010.396



BOLT

Bolt, washer and nut 105mm (4.1") long

503014



W-CLIP

For LUCAS freestanding headlamps

504665



SMALL RIM CATCH

Small, 31mm long and 27mm wide, as fitted to freestanding headlamps

509936



BOLT

Bolt Washer and Nut 55mm long 5/8 in dia 26. Bolt length 55mm (2.2")

503890



7" CHROME RIM

Fits to LUCAS S700 freestanding headlamps

553248/R

HEADLAMPS COVERS

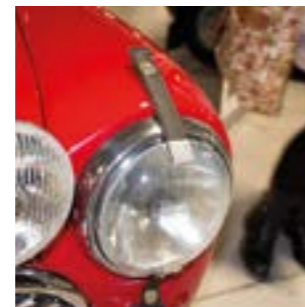

Perspex headlamp covers for 7" headlamps. These are just like the ones that were used on works Mini Coopers. Leather mounting straps and fittings included

010.004 Headlamp covers



LUCAS SPOT/FOG LAMPS



7" FOGLAMP

A quality reproduction of the LUCAS 7" foglamp SFT700 fitted to many cars in the classic period. Chrome back

SFT700/R



7" SPOTLAMP

A quality reproduction of the LUCAS 7" spotlamp SLR700 fitted to many cars in the classic period. Chrome back and curved glass

SLR700/R

BASE MOUNTING



LUCAS 5 3/4" FOG LAMP

This is the LUCAS 5 3/4" foglamp you always saw on cars during the classic period

SFT576



LUCAS 5 3/4" SPOTLAMP

This LUCAS 5 3/4" spotlamp matches the foglamp on the left

SLR576

REAR MOUNTING



5 3/4" FOG LAMP

This is the rear mounted LUCAS 5 3/4" foglamp you often saw on cars and motorcycles during the classic period This is a reproduction, close to original LUCAS

WFT576



5 3/4" SPOTLAMP

This rear mounted LUCAS 5 3/4" spotlamp matches the foglamp on the left This is a reproduction, close to original LUCAS

WLR576



5 3/4" REPRODUCTION LIGHT UNIT

Reproduction of light unit for LUCAS SFT576 and WFT576

LUB106



5 3/4" REPRODUCTION LIGHT UNIT

Reproduction light unit for LUCAS spotlamps SLR576 and WLR576

LUB107



LUCAS 5LR SPOTLAMP

LUCAS 5LR Spot -Ranger Freestanding Spot Lamp. 150mm Diameter

5LR



LUCAS 5FT FOG LAMP

LUCAS 5FT Fog-Ranger Freestanding Fog Lamp 150mm Diameter

5FT



5 3/4" LUCAS FOG RANGER FOG LAMP

This is the LUCAS Fogranger Foglamp as fitted to Mk II Jaguars and Vanden Plas 1300. Includes bulb

WFT5



SQUARE 8 FOG LAMP & SPOTLAMP

LUCAS licenced reproduction of the Square 8 Fog Lamp and Spotlamp which were fitted below the bumper on Rolls-Royce Shadows and Bentley T Types. With chromed body and black cover. Approximately 180mm wide by 105mm tall. E Marked. Entirely suitable for other classic cars. Foglamp shown on left

FT8/C Foglamp

LR8/C Spotlamp

54525340 Spare Cover

LIGHTING

SWITCHES

IGNITION

WIRING

HEATERS & ELECTRIC FANS

ACCESSORIES

BODY HARDWARE

BRAKES & SUSPENSION

CLUTCH KITS

EXHAUSTS

FIXINGS

FUEL SYSTEMS & FILTERS

GAUGES

MIRRORS

POWER STEERING

SEATS & SEAT BELTS

WASHERS & WIPERS

OIL & AIR FILTERS

CARE & STORAGE

OIL, GREASE & FLUIDS

PAINT & ANTI-RUST

TOOLS



5" HIGH POWER DRIVING LAMPS (PAIR)

12V. Base mounted 5" diameter spot lights, supplied as a pair and complete with 12 volt H3 Halogen bulbs. 6 volt bulbs are available to purchase separately should these be required. A bracket is available to mount these lamps to a badge bar.

010.485 Chrome
010.4001 Black



5 1/4" WIPAC DRIVING LAMPS (PAIR)

Base mounting with chrome finish and 12V halogen bulbs. Approx 130mm (5 1/4") dia. Supplied with plastic covers

010.484



BULBHOLDER

Double Contact Bulbholder for amber bulb **LLB409** to convert LUCAS fog lamp **SFT576** to be used also as indicators as was done on Rolls-Royce

554946



LAMP BRACKET

For **010.455** Fits 19mm (3/4") badge bar. You will need two to fit the pair of lamps **010.455**

090.632



BULBHOLDERS

These bulbholders fit many 1970s rear lamp clusters

010.154 Single contact
010.155 Double contact



FLYING BULBHOLDERS

(With 130mm lead(s), earthed through the body)

010.720 Single contact **BA9S**
010.721 Single contact **BA15S**
010.722 Double contact **BA15D**

These lenses are made on the original BUTLER's tools using the originally specified polymers



AMBER LENS OFFSIDE

For **Ford Anglia** Amber lens for offside
BA-FPI-59AO



AMBER LENS NEARSIDE

For **Ford Anglia** Amber lens for nearside
BA-FPI-59AN



CLEAR LENS OFFSIDE

For **Ford Anglia** Clear lens for offside
BA-FPI-59CO



CLEAR LENS NEARSIDE

For **Ford Anglia** Clear lens for nearside
BA-FPI-59CN

*'Offside' is right hand side seen from the driver's seat looking forward

L488-These have a glass lens and a rim diameter of 71.5mm and require a hole size of 33.4mm



SIDELIGHT

Clear lens
Single contact
As fitted to **Rover P4**

L488/A



FLASHER LAMP

Amber lens
Single contact
As fitted to **Austin, Armstrong Siddeley** etc.

L488/B



SIDE/FLASHER LAMP

Clear lens
Double contact
As fitted to **Aston Martin, Allard, Hillman** etc.

L488/C



REAR LAMP

Red lens
Double contact

L488/D



SIDE/FLASHER LAMP

Amber lens
Double contact
For **USA and Europe**

L488/E

SPARE PARTS:

Chrome Rim **L488/572734**
Clear Lens **L48854583038**
Red Lens **L48854570664**
Amber Lens **L488/573266**

Rubber Body
Single Contact Base and Bulbholder
Double Contact Base and Bulbholder

L488/575003
L488/573285
L488/572727

L539-These have an ORIGINAL GENUINE LUCAS LENS and a rim diameter of 83mm and require a hole size of 33mm



SIDE LAMP

LUCAS type **L539** Single contact clear side lamp. 75mm diameter
L539/A



FLASHER LAMP

LUCAS **L539** Type Single contact flasher lamp. 75mm diameter
L539/B



SIDE/FLASHER LAMP

Clear lens, double contact. As fitted to **AC, Bristol, Daimler and MGA**
L539/C

SPOTLAMP BRACKETS

These chrome plated brackets suit **SLR576** and **SFT 576**. As used on **MGA** when new

010.602 Left hand
010.603 Right hand



MOUNTING PLINTH

Tall chrome type for fitting extra lamps on **Rolls-Royce & Bentley**

010.010



STABILISER BARS

All metal. They require two holes in the lamp and two in the car. Length between centres can be adjusted from 120 to 175mm

010.443



STABILISER BARS

They require one hole in the lamp and one in the car. Length between centres 205mm, but they can be cut down

010.444

SPARES FOR FFT462 FOG/PASS LAMP

Spares for **FFT462** Fog/Pass Lamp fitted to **Armstrong Siddeley Sapphire, Bristol 403, Jaguar 2 1/2 & 3 1/2 litre Mark 5 1951, Riley Pathfinder 1954-7**

010.129 Backshell
010.367 Dust Seal



SIDE AND FLASHER LAMPS

REPAIR BULBHOLDERS

These three Bulbholders enable you to repair your side or rear lamps, or make up your own lamps. They fit into a 22mm hole, you then swage the flange to secure. If the body of the lamp is non metallic or not giving a good earth, then this Earthing Ring (shown right) can be used to complete the connection



BULBHOLDER SINGLE CONTACT

Takes bulbs **LLB382, LLB343, LLB316** or **LLB317**. Comes with a wire to enable you to connect up
010.393



BULBHOLDER DOUBLE CONTACT

Takes bulbs **LLB384** or **LLB380**. Comes with two wires to enable you to connect up
010.394



BULBHOLDER DOUBLE CONTACT

Takes bulbs **LLB384** or **LLB380**. For wiring use Sleeve Connector **555910**
554292



Earthing Ring (shown right) can be used to complete the connection
010.399

LIGHTING

SWITCHES

IGNITION

WIRING

HEATERS & ELECTRIC

FANS

ACCESSORIES

BODY HARDWARE

BRAKES & SUSPENSION

CLUTCH KITS

EXHAUSTS

FIXINGS

FUEL SYSTEMS & FILTERS

GAUGES

MIRRORS

POWER STEERING

SEATS & SEAT BELTS

WASHERS & WIPERS

OIL & AIR FILTERS

CARE & STORAGE

OIL, GREASE & FLUIDS

PAINT & ANTI-RUST

TOOLS

LIGHTING

SWITCHES

IGNITION

WIRING

HEATERS & ELECTRIC

FANS

ACCESSORIES

BODY HARDWARE

BRAKES & SUSPENSION

CLUTCH KITS

EXHAUSTS

FIXINGS

FUEL SYSTEMS & FILTERS

GAUGES

MIRRORS

POWER STEERING

SEATS & SEAT BELTS

WASHERS & WIPERS

OIL & AIR FILTERS

CARE & STORAGE

OIL, GREASE & FLUIDS

PAINT & ANTI-RUST

TOOLS

L539—These have an ORIGINAL GENUINE LUCAS LENS and a rim diameter of 83mm and require a hole size of 33mm.



REAR LAMP
This lamp has original genuine LUCAS red lens. Double contact bulb. Fitted to many cars.
L539/D
For a reflector to match this lamp see part no. **010.375**



SIDE/FLASHER LAMP
Amber lens, double contact for USA and Europe.
L539/E



SINGLE CONTACT BASE
Single Contact Base for L539 Lamps using a single filament bulb.
L539/S.F.
L539/D.F. Double Contact Base

SPARE PARTS:

Clear Lens and Rim **L539/574258** Amber Lens and Rim **L539/574267** Red Lens and Rim **L539/574259**

L551—quality reproduction of LUCAS original with a rim diameter of 97mm. ORIGINAL GENUINE LUCAS LENS



SIDE/FLASHER LAMP
Clear lens, two bulbs
L551/C



REAR LAMP
L551/D Red Lens, two bulbs
L551/574609 Red Lens
L551/DLR Red Lens & Rim



SIDE/FLASHER LAMP
Amber lens, two bulbs
L551/E

L594—These have a glass lens and a rim diameter of 71.5mm and require a hole size of 33.4mm



SIDELIGHT
Clear lens
Single contact
As fitted to Austin, Reliant, Standard Vanguard
L594/A



FLASHER LAMP*
Amber lens
Single contact
As fitted to Mini, Morgan, Lotus
L594/B



SIDE/FLASHER LAMP
Clear lens
Double contact
As fitted to Austin Healey, Standard, Triumph
L594/C



REAR LAMP
Red lens
Double contact
L594/D



SIDE/FLASHER LAMP
Amber lens
Double contact
For USA and Europe
L594/E

SPARE PARTS:

Clear Lens **L59454581622** Single contact base **L59454584780** Rubber Body **L594/576105**
Red Lens **L594/576109** Double contact base **L594/576985** Chrome Rim **L488/572734**
Amber Lens **L59454581651**

L691—These have a rim diameter of 82.6mm and require a hole size of 33.4mm E marked



SIDELIGHT
Clear lens
Single contact
As fitted to Austin Healey
L691/2A



FLASHER LAMP
Amber lens
Single contact
As fitted to Austin Healey Hillman Imp Morgan
L691/2B



SIDE/FLASHER LAMP
Clear lens
Double contact
As fitted to Austin Healey Morgan
L691/2C



REAR LAMP
Red lens
Double contact
L691/2D



SIDE/FLASHER LAMP
Amber lens
Double contact
Order For USA and Europe
L691/2E

SPARE PARTS:

Clear Lens **L69154581109** Amber Lens **L69154581233**
Red Lens **L69154581204** Base rubber **L691/B.R.**



LUCAS TYPE BASE

Single contact base unit c/w bulb holder for L691 lamps also fits the L794 lamp
L691/S.F.
L691/D.F. Double contact base

Overall diameter 73mm, requires hole 35mm diameter. These are a Land Rover style and a copy of the LUCAS L760



SIDELIGHT
Clear Lens, single contact
010.580



FLASHER LAMP
Amber Lens, single contact
010.581



REAR LAMP
Red Lens, double contact
010.582



LENS
Clear lens only for **010.580**
010.580L



LENS
Amber lens only for **010.581**
010.581LA



LENS
Red lens only for **010.336L**
010.336L



SIDELAMP L451
LUCAS L451 replica Sidelamp, as fitted to Rolls-Royce Wraith and Dawn, Bentley Mk VI, R Type, and Land Rover Series 1.
L451



SIDELAMP L461
LUCAS L461 sidelight, as fitted to Jaguar Mark 10, 420 Saloon, S type, Bentley and Daimler. Jaguar C21538
L461/52120



SIDELAMP L490
As fitted to Jaguar Mk II, Early XK, Armstrong Siddeley, diameter 30mm, depth 6mm (shown)
L490/52474



SIDELAMP L490
As Housing for L490/52474 (see left)
L490/HOUSING



SIDELAMP L489
60 mm diameter x 30 mm deep, as fitted to early Morris Minor
L489/52139
L489/572763 Rubber Body only



SIDELAMP L513
As fitted to Jaguar XK150, Daimler, diameter 45mm, depth 12mm
L513/52175

LIGHTING
SWITCHES
IGNITION
WIRING
HEATERS & ELECTRIC FANS
ACCESSORIES
BODY HARDWARE
BRAKES & SUSPENSION
CLUTCH KITS
EXHAUSTS
FIXINGS
FUEL SYSTEMS & FILTERS
GAUGES
MIRRORS
POWER STEERING
SEATS & SEAT BELTS
WASHERS & WIPERS
OIL & AIR FILTERS
CARE & STORAGE
OIL, GREASE & FLUIDS
PAINT & ANTI-RUST
TOOLS

LIGHTING
SWITCHES
IGNITION
WIRING
HEATERS & ELECTRIC FANS
ACCESSORIES
BODY HARDWARE
BRAKES & SUSPENSION
CLUTCH KITS
EXHAUSTS
FIXINGS
FUEL SYSTEMS & FILTERS
GAUGES
MIRRORS
POWER STEERING
SEATS & SEAT BELTS
WASHERS & WIPERS
OIL & AIR FILTERS
CARE & STORAGE
OIL, GREASE & FLUIDS
PAINT & ANTI-RUST
TOOLS



PILOT OR SIDELAMP L517
Fitted to **Triumph motorcycles** and also on the **Daimler SP250 L517**



SIDELAMP L552
Made on the original tools. For **Rolls-Royce Silver Cloud I/II and Bentley S1/2**
L552
L522/LENS Clear Lens only



SIDELAMP L794
Chrome Rim and clear domed lens. 80mm diameter x 60mm deep. Single contact. Matches Flasher Lamp **L794/54990**
L794/A
L79453202497 Spare Lens Only



FLASHER LAMP L794
LUCAS **L794** Flasher Lamp, used as a front and rear flasher lamps on Morgan cars from the early 1970s to present day. Clear lens and amber bulb combination could be substituted if required. 'E' Marked
L794/54990
L79454581353 Spare Lens Only



SIDELAMP L566
LUCAS **L566** Lens sidelight lens. As fitted to **Jaguar Mk1**
010.5004



SIDELAMP L566
Rubber Back Gasket. As fitted to **Jaguar Mk1**
010.5003



FLASHER LAMP L584
As fitted to **MG Midget**, length 150mm, height 55mm, depth 30mm
L584/52506 Left hand side
L584/52507 Right hand side



SIDE/FLASHER LAMP L632
Diameter 95mm, depth 45mm. **MGA, Morris Minor**
L632/52572 Original
L632/REPRO Reproduction
L63254570381 Gasket



L827 SIDELAMP AMBER/CLEAR LENSES
With chromed edge for the Side/Flasher Lamp on **Triumph TR6 1969-1972**
L82754579196 Right side
L82754579197 Left side



FRONT SIDE / FLASHER LENS
LUCAS **L941**. For **Lotus Esprit 1986**. Front Side & Flasher Lens only
A089M6061F



SIDE/FLASHER LAMP L811
Side and Flasher Lamp of **Mini Clubman, 1275GT, Lotus Elite, Eclat and Esprit**
L811/57329
L81154592181 Spare Lens Only



SIDELAMP L797
LUCAS **L797** front side flasher lamp, fitted to **Lotus Elan Plus 2** replaces **52867/52848**
L797



SIDE/FLASHER LAMP L652
As fitted to **Jaguar Series I 'E' Type** length 260mm, height 55mm, depth 25mm
L652/52787 Right hand side
L652/52788 Left hand side
L652/GASKETS Gaskets
L65254572374 Indicator/Side Lamp Lens - Amber/Clear



SIDELAMP L658
As fitted to **Lotus, TR, Aston Martin**, diameter 40mm, depth 25mm
L658 With Clear Lens
L658/A With Amber Lens



SIDE/FLASHER LAMP L677
As fitted to **Aston Martin, MGB, Triumph Spitfire Mk II**. Length 150mm, height 55mm, depth 45mm
L677/54894



SIDELAMP L823
Front side and indicator lamp Amber lens
L823/54796 Right Hand Side
L823/54797 Left Hand Side



SIDELAMP L823
Front right hand side and indicator lamp Amber/Clear Lens
L823/54761 Right Hand Side
L823/54762 Left Hand Side
L82354584076 Amber Lens Left Hand (12793)



SIDELAMP L823 US SPECIFICATION
LUCAS **L823** front side and indicator lamp For **E type S2 and S3 C34711** Amber lens
L823/56237 Left hand side
L823/56236 Right hand side
L82354579184 Right Hand Side Lens Only

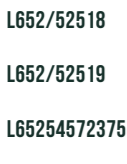

SIDELAMP L715
LUCAS **L715** front side and indicator lamp. As fitted to **Rolls Royce and Bentley, Silver Cloud III & S3, All Shadow & T Type models**
UD17813



SIDELAMP L721 CLEAR LENS
Clear Lens for **Rover 2000 and V8**. Genuine original LUCAS
L72154580491



BASE L721
Quality reproduction of the LUCAS **L721** sidelamp for **Rover P6**
L721/BASE Base Only



L768
Complete Lens
L768/56255
L76854581076 L768 Amber Lens
Rolls Royce Silver Shadow 2 CD3119



FLASHER LAMP L901
Front indicator lamp Amber Lens
L901/R Right Hand Side
L901/L Left Hand Side
L901/RH Right Hand Side Lens Only
L901/LH Left Hand Side Lens Only



SIDELAMP L901
Front sidelamp / Indicator lamp Amber/Clear Lens
L901/56866 Right Hand Side
L901/56867 Left Hand Side
L901RHAC Right Hand Side Lens Only
L901LHAC Left Hand Side Lens Only



FRONT SIDE / FLASHER LAMP L943
L943/56934 Right Hand Side
L943/R RH Lens (Rolls Royce Silver Spirit & Bentley Mulsanne)
L943/L LH Lens (Rolls Royce Silver Spirit & Bentley Mulsanne)
L943/RHLENS RH Lens (Rolls Royce Spirit)
L943/LHLENS LH Lens (Rolls Royce Spirit)
L94354591613 Right Hand Clear Lens

The originals of these lamps were fitted to many cars in the vintage and pre-war period, all 12 volt



1130 SIDELAMP

Cast body, clear plastic lens. No rim. Single filament

1130-4

Double filament

1130-5



1130 SIDELAMP WITH MEDALLION

Drawn body with medallion, clear glass lens, chrome rim. Double filament

1130-6

(Single filament version no longer available)

As above but with two bulbs inside - one for the sidelight and an amber one for the flasher. This means you don't have to put separate flashers on your vintage car

1130-6F



1130 SIDELAMP WITH RED DOT

Drawn body with red dot, clear glass lens and chrome rim. Double filament

1130-2

(Single filament version no longer available)

As above but with two bulbs inside - one for the sidelight and an amber one for the flasher. This means you don't have to put separate flashers on your vintage car

1130-2F

SPARE PARTS FOR 1130 SIDELAMPS



Base rubber
010.301



Bulbholder for single filament bulb
010.303



Bulbholder for double filament bulb
010.304



O Ring For 1130 Side Lamp Lens
53201587



Rim Screw
010.300



Glass Lens & Rim (only for pre '95 bodies)
010.305



LUCAS Type Red Dot for 1130 Sidelamps
574874



VINTAGE STYLE SIDELAMP

Reproduction of a Sidelamp popular in the vintage days. Chrome plated with red dot and frosted glass lens. Single filament. Normally mounted on the top of the wing. Approximately 55mm diameter. Rim pulls off to change the bulb

LD109



VINTAGE STYLE SIDELAMP

With chrome rim and body as fitted to *Austin A35, Jensen, Bristol, Morgan*

L516/52436

Rubber base only

L516/573618



SIDEMARKER L824

Amber Sidemarker Lamp, Deep Lens

L824/DEEPRH

Right Hand Side

L824/DEEPLH

Left Hand Side



SIDEMARKER L824

Amber Sidemarker Lamp Lens

L82454579913

RH Lens Only

L82454579190

LH Lens Only

SIDEMARKER L824

Amber Sidemarker Lamp. As fitted to the front left hand side of **MGBs** (OEM No. **BHA4968** and **BHA4969**) and **TVRs**

L824/54920

Right Hand Side

L824/54921

Left Hand Side



SIDEMARKER L824

Amber Sidemarker Lamp Lens

L82454579189

RH Lens Only

L82454579912

LH Lens Only



SIDEMARKER L824

Red Sidemarker Lamp, Deep Lens

L824/54972

Right Hand Side

L824/54971

Left Hand Side



SIDEMARKER L824

Red Sidemarker Lamp. As fitted to the front of **MGBs** for the USA 1970-1980 (OEM No. **BHA4971** and **BHA4970**)

L824/54923

Right Hand Side

L824/54922

Left Hand Side



SIDEMARKER L824

Red Sidemarker Lamp Lens

L82454581247

RH Lens Only

L82454581248

LH Lens Only



L734 SIDEMARKER

Length 77mm, height 23mm, depth 24mm

L734/56859

L73454573645 Spare Amber Lens

73454578654 Alternative Red Lens



L773 SIDEMARKER

LUCAS **L773** Amber Side Repeater Lamp Front

L773/54903



SIDEMARKER L826

Amber Sidemarker Lamp. As fitted to *Triumph TR6*

L826/52941

Right Hand Side

L826/52942

Left Hand Side



L841 SIDEMARKER

L841 With red lens and reflector. 125mm x 48mm

L841/LHR LUCAS **L841** Left Hand Rear Side Marker

L841/LHF LUCAS **L841** Left Hand Front Side Marker with amber lens and reflector

L841/RHR LUCAS **L841** Right Hand Rear Side Marker

L841/RHF LUCAS **L841** Right Hand Front Side Marker with amber lens and reflector

LIGHTING
SWITCHES
IGNITION
WIRING
HEATERS & ELECTRIC FANS
ACCESSORIES
BODY HARDWARE
BRAKES & SUSPENSION
CLUTCH KITS
EXHAUSTS
FIXINGS
FUEL SYSTEMS & FILTERS
GAUGES
MIRRORS
POWER STEERING
SEATS & SEAT BELTS
WASHERS & WIPERS
OIL & AIR FILTERS
CARE & STORAGE
OIL, GREASE & FLUIDS
PAINT & ANTI-RUST
TOOLS

LIGHTING
SWITCHES
IGNITION
WIRING
HEATERS & ELECTRIC FANS
ACCESSORIES
BODY HARDWARE
BRAKES & SUSPENSION
CLUTCH KITS
EXHAUSTS
FIXINGS
FUEL SYSTEMS & FILTERS
GAUGES
MIRRORS
POWER STEERING
SEATS & SEAT BELTS
WASHERS & WIPERS
OIL & AIR FILTERS
CARE & STORAGE
OIL, GREASE & FLUIDS
PAINT & ANTI-RUST
TOOLS



FLASHER LAMP L563
Indicator. As fitted to **Jaguar Mk II, XK**
L563/52479 Amber
5322 Rim and Lens only



FLASHER LAMP L563
Clear indicator lamp. Fits **Jaguar Mk 2 XK 140**
and **XK 150** American spec
L563/52480 Clear
L563/575285 Rim and Lens only



FLEXIBLE STEM WITH SCREW MOUNT
Motorcycle type with flexible black plastic body and single hole for fixing to fairing or bracket. Amber lens is 'E' marked and measures 46mm x 61.5mm. In addition the 26mm depth of lens gives a good light from the side. Overall length 104mm. Supplied with a 12 volt 10 watt bulb fitted
010.511



EXTENDABLE FLASHER LAMP
Motorcycle type with black metal body and 8mm bolt mount. Amber lens measures 35mm x 62.5mm. Overall length 90 mm but can be extended. Supplied with 12V 10 watt bulb fitted
010.514



FLASHER LAMP L794
Diameter 80mm depth 60mm. 'E' Marked. As fitted to **Morgan**
L794/54990 Amber
L79454581353 Spare Amber Lens
L79453202497 Clear Lens. This enables you to update your **Morgan**
L79453203696 Pair of Lens Retaining Screw for **L794** lamps

For matching Sidelamp refer to **L794/A**



FRONT FLASHER LAMP L931
L931/57609 Flasher lamp
L931/56709



L930 FLASHER LAMP
For **MG Midget 1500** UK Spec
L930



FRONT INDICATOR LAMP L990
Amber. Front Direction Indicator Lamp
L990RHF Right Hand Side
L990LHF Left Hand Side
L990RHF Right Hand Side USA
L990LHF Left Hand Side USA



REAR INDICATOR LAMP
Special rear indicator lamp, fits into reflector housing on early **Austin Healey 100/6, 3000**
010.114



FLASHER LAMP/BACKET
Flasher lamp with bracket, 45mm diameter over rubber body, 'E' Marked
010.153



BULLET STYLE FLASHER LAMP
Supplied with the bulb.
Length: 80mm, Height: 70mm
010.5001 black
010.5002 chrome



FLASHER LAMPS
A Motorcycle Flasher Lamp that is also useful for cars. On chromed tubular bracket. 70mm diameter, depth 90mm
LUCAS original with 80mm tall bracket **L874/80MM**
Reproduction of above **010.553**
LUCAS original with 125mm tall bracket **L874/125MM**
Reproduction of above **010.554**
Amber Lens only for **L874** lamps **L874/60600621**

RIGID STEM WITH SCREW MOUNT
Motorcycle type with black plastic body and single hole for fixing to fairing or bracket. Amber lens is 'E' marked and measures 46mm x 61.5mm. In addition the 26mm depth of lens gives a good light from the side. Overall length 104mm. Supplied with 12 volt 10 watt bulb fitted
010.510



FLEXIBLE STEM FLASHER LAMP
Motorcycle type with 10mm bolt mount. E Marked
010.512



FLEXIBLE STEM FLASHER LAMP
Motorcycle type with bolt mount. Black plastic body and 10mm bolt mount. Oval amber lens is E marked and measures 44mm x 52.5mm. Overall length 97mm. Supplied with 12 volt 10 watt bulb fitted
010.513

REAR LAMPS



REAR LAMP L471
As fitted to the **TD** version of the **MG** to chassis no. 21302 but could be fitted to any similar sloping rear wing. Supplied with double contact bulb for rear and brake lights. Red glass lens, chromed rim, gaskets and fitting screws
L471 Spare Glass Lens
L471/572239



MILLER STOP / TAIL LAMP
Reproduction of the original Miller stop/tail/numberplate lamp. As fitted to **Vincent B & C** models
010.546



REAR LAMP
All plastic. Stop, Tail but no numberplate illumination. 70mm diameter, 40mm deep. 'E' marked
010.336



NUMBERPLATE LAMP MT211
Reproduction of LUCAS **MT211** number plate lamp. Converted to include stop/tail. Fits many motorcycles from 1936-1950 and can also be used on cars. LUCAS No. **53056**
MT211/R



NUMBERPLATE LAMP MT110
Reproduction of LUCAS **MT110** number plate lamp converted to stop/tail. The red lens has a chrome rim 40mm diameter and the fitting flange is approx 65mm diameter. It also illuminates a numberplate beneath it. As fitted to motorcycles from the 1930s to the 1950s and can also be used on cars
MT110



REAR/NUMBERPLATE L679
Reproduction LUCAS, as fitted to many British motorcycles 1964-72
L679/53973

LIGHTING
SWITCHES
IGNITION
WIRING
HEATERS & ELECTRIC FANS
ACCESSORIES
BODY HARDWARE
BRAKES & SUSPENSION
CLUTCH KITS
EXHAUSTS
FIXINGS
FUEL SYSTEMS & FILTERS
GAUGES
MIRRORS
POWER STEERING
SEATS & SEAT BELTS
WASHERS & WIPERS
OIL & AIR FILTERS
CARE & STORAGE
OIL, GREASE & FLUIDS
PAINT & ANTI-RUST
TOOLS

LIGHTING
SWITCHES
IGNITION
WIRING
HEATERS & ELECTRIC FANS
ACCESSORIES
BODY HARDWARE
BRAKES & SUSPENSION
CLUTCH KITS
EXHAUSTS
FIXINGS
FUEL SYSTEMS & FILTERS
GAUGES
MIRRORS
POWER STEERING
SEATS & SEAT BELTS
WASHERS & WIPERS
OIL & AIR FILTERS
CARE & STORAGE
OIL, GREASE & FLUIDS
PAINT & ANTI-RUST
TOOLS



MILLER REAR/NUMBERPLATE
Reproduction of the Miller No. 38 ET. Fits most **Velocettes** 1957-67, **Royal Enfield** 150cc 1957 onwards
010.547



REAR / NUMBERPLATE L525
Lamp for early **TR**, **Lotus MK IX** also for motor cycles
L525
L525/B Lens only. LUCAS part number **573819**



REAR / NUMBERPLATE L917
Reproduction of LUCAS stop, tail, numberplate lamp. Fitted to many British motorcycles from 1973-83
L917/56513



L813 REAR LAMP
As fitted to **Mini Mk II**
Left hand side
L813/LH
Right hand side
L813/RH



L940 REAR LAMP
As fitted to **Mini Mk III**
Left hand side
L940/57355 Right hand side
L940/57354 Right hand side, clear lens only
L940/54590548 Right hand side, clear lens only
L940/54590549 Left hand side, clear lens only
L940/54590545 Red/Amber lens only for left hand side



REAR / NUMBERPLATE L564
Reproduction Lamp for motor cycles. As fitted to many Classic British Motorcycles (1955-70), including **Triumph, BSA, Norton, AM**
L564/53454 Genuine Lucas Classic L564 Complete Rear Lamp
L564 Reproduction



REAR LAMP L687
LUCAS **L687** rear lamp Right and Left hand side
L687/53936
L687 54571777 Top Red Indicator Lens Only
L68754573423 Top Amber Indicator Lens Only
L68754120000 Bottom Red Stop & Tail Lens Only
L687 RH and LH with Red and Amber lens



REAR TAIL / STOP LAMP ASSEMBLY L783
Rear Tail / Stop Lamp Assembly LUCAS **L783**. As fitted to **Rolls Royce Corniche** and **Bentley Continental**
UD74955
L78354576579 Amber Lens



L549 REAR LAMP
As fitted to **Morgan, TR, MGA** etc.
L549/53330
High Quality LUCAS Reproduction
L549/13H23



L549 REAR LAMP
As fitted to **Morris Minor** (right hand side shown in photograph)
L549/53576 Right hand side
L549/53577 Left hand side
L549/574635 Lens



L759 REAR LAMP
Triumph Herald and **Vitesse** rear lamp
L759/54269
L75954580555 rear lamp lens



LAMP LENS L944
Left hand lens All Red, fits U.S. Spec **Bentley Mulsanne**
L944/CD6261



L548 REAR LAMP
High quality reproduction of the LUCAS rear lamp as fitted to **Humber Hawk** 1955-57
L548/53464



LUCAS L651 REAR LAMP ASSEMBLY
L651/53820 for **Jaguar Series 'E' Type D.H.C.** Left hand
L651/53866 for **Jaguar Series 'E' Type D.H.C.** Right hand
L651/53867 for D.H.C. Left hand, all red lens. US specification
L651/53868 for D.H.C. Right hand, all red lens. US specification **C16086**
L651/53947 for the very early **E type S1** and **S1.5 FHC** Left hand side- **C17932**
L651/53948 for the very early **E type S1** and **S1.5 FHC** Right hand side- **C17931**
L651/54128 for **E type S1** and **S1.5 FHC** Right hand side
L651/54129 for **E type S1** and **S1.5 FHC** LUCAS **L651** Rear lamp assembly
L651/54130 for **E type S1** and **S1.5 FHC** Right hand, all red lens. US specification
L651/54131 for **E type S1** and **S1.5 FHC** Left hand, all red lens. **C19857**
L651/54365 Right hand **E type 2+2 C25194**
L651/54366 Left hand **E type 2+2 C25195**
L651/54572373 All red lens as fitted to US Market **Jaguar E Type series 1 8512**
L651/DGASKETS **Jaguar E Type** Gaskets for drop head cars, pair
L651/FGASKETS **Jaguar E Type** Gaskets for fixed head cars, pair
L651/54572372 Lens



L548 REAR LAMP
With amber/red lenses as fitted to **Aston Martin DB4, Alvis TD21, Humber Hawk, Rolls-Royce & Bentley** and **Special Bodies**
L548
Top lens only: **L54854571070** Amber **L54854571071** Red
Lower lenses only: **L54854571072** Red **L548/574550** Back gasket
L548/574558 Clear **L548/SCREWS** 3 Screws
L548/574560 Chromed rim



REAR LAMP L701
Complete Lamp for **Rolls-Royce Silver Cloud III** and **Bentley S3**
L701 Amber lens only
L70154572670
Red lens only
L70154572750



REAR LAMP L657
LUCAS **L657** Rear Lamp, **Mini Van/Mini Pickup**
L657



REAR LAMP L672
As fitted to **Triumph Spitfire Mk I, II and III** and **GT6**. Also used on **Kit Cars**
L672/54138 Red lens only
L67254580753



REAR LAMP L542
As fitted to **AC Cobra & Ace, Jensen 541, Hillman Minx**
L542/REPRO



L676 REAR LAMP
As fitted to **Early MG Midget & MGB**
L676
L67654571434 Amber Lens only
L676/53915 L676 High quality version



L840 REAR LAMP
As fitted to **Later MG Midget & MGB**
L840
L84054584009 Amber/Red Lens only



L669 REAR LAMP
As fitted to **Triumph TR4, 4a, 5, Aston Martin DB6**
L669/53939
L66954572680 Amber/Red lens only



L647 REAR LAMP
As fitted to **Mini Mk I Left Hand, MGA Right Hand**
L647/53797
As fitted to **Mini Mk I Right Hand, MGA Left Hand**
L647/53798

LIGHTING

SWITCHES

IGNITION

WIRING

HEATERS & ELECTRIC FANS

ACCESSORIES

BODY HARDWARE

BRAKES & SUSPENSION

CLUTCH KITS

EXHAUSTS

FIXINGS

FUEL SYSTEMS & FILTERS

GAUGES

MIRRORS

POWER STEERING

SEATS & SEAT BELTS

WASHERS & WIPERS

OIL & AIR FILTERS

CARE & STORAGE

OIL, GREASE & FLUIDS

PAINT & ANTI-RUST

TOOLS

LIGHTING

SWITCHES

IGNITION

WIRING

HEATERS & ELECTRIC FANS

ACCESSORIES

BODY HARDWARE

BRAKES & SUSPENSION

CLUTCH KITS

EXHAUSTS

FIXINGS

FUEL SYSTEMS & FILTERS

GAUGES

MIRRORS

POWER STEERING

SEATS & SEAT BELTS

WASHERS & WIPERS

OIL & AIR FILTERS

CARE & STORAGE

OIL, GREASE & FLUIDS

PAINT & ANTI-RUST

TOOLS



L807 REAR LAMP
As fitted to Lotus Elan & Europa (UK/European spec)

- L807/54792** Elan, +2, Elan S4, Europa, left hand side
- L807/54793** Elan, +2, Elan S4, Europa, right hand side
- L80754581628** Lens for L807/54792
- L80754581629** Lens for L807/54793
- L807/54621** E type S2 Right hand lamp assembly
- L807/54579880** E type S2 Left hand lamp assembly
- L807/54579870** Right hand rear lens, all red
- L807/54622** E type S2 Left hand lamp assembly



L807 REAR LAMP
As fitted to V12 Jaguar 'E Type'

- L807/54763** Right hand side
- L807/54780** Left hand side
- L80754580256** Lens for L807/54763
- L80754580253** Lens for L807/54780

L807/BACK GASKET Pair of Back Gaskets for L807 rear lamps on Jaguar V12 E Type and Lotus Elan and Europa



REAR LAMP L871
All Red Lens E-Type S2/3 North American Lamp

- L871/56254** Left hand Side
- L871/56253** Right hand Side
- L87154581586** LH Lens only
- L87154581613** RH Lens only



L494 FOG LAMP
Reproduction of LUCAS lamp supplied as an aftermarket item for many years
L494/R



L494 REVERSING LAMP
Reproduction of LUCAS lamp supplied as an aftermarket item for many years
L494



5 3/4" FOGLAMP
This is the rear mounted 5 3/4" foglamp you often saw on cars and motorcycles during the classic period. Reproduction, close to original LUCAS
WFT576



5 3/4" SPOTLAMP
This rear mounted 5 3/4" spotlamp matches the foglamp on the left. Reproduction, close to original LUCAS
WLR576



REAR LENS L553
Rear Lamp as fitted to Rolls-Royce Silver Cloud I/II & Bentley S1/2. Made on the original tools using the originally specified polymers (Rolls-Royce Part No. CD2864 and CD2863)
L553574945/6 Red lens only
L553574720 Amber lens only



AMBER LENS L587
The top amber Lens for the LUCAS L587 Rear Lamp on Humber Hawk and Super Snipe. These lenses are made on the original LUCAS tooling
L587/576268



RED LENS L671
As fitted to Volvo P1800 for L671 Rear lamp
L671
The red lens only for the L671 rear lamp fitted to the Volvo P1800
L671/7145



REAR LENS L977
LUCAS L977 Rear Left hand lens SAE marked
CD6261



REVERSING LAMP L798
As fitted to MGB & Midget 75mm x 60mm
L798/54462



REVERSING LAMP L595
As fitted to 'E' Type Jaguar
L595/52549



LAMP L512
Stamped LUCAS 512 made in England. Fits Jaguar Mk 1,2,7,9, 240,340 and XK150
L512573513



REVERSE LAMP L925
Lens only - comes with mounting screws/washers and mounting gasket AAU2045
L92554585718 LH Clear Lens
L92554585719 RH Clear Lens



RED STOP / TAIL LENS L627
LUCAS L627 Red Lens. Jaguar MK11 and XK150 stop tail lens 54570229
L62754570229



REAR INDICATOR LENS L627
LUCAS L627 Rear indicator, lens only
L62754570228 Red lens only
L62754570227 Amber lens only



REAR INDICATOR LENS L769
LUCAS L627 Rear indicator, lens only
L769 Red lens only
L76954577245 Amber lens only



REAR LENS L801
Red and Amber Stop, Tail & indicator lens only. Fitted to Jaguar XJ6 S1, XJ12 S1, and Daimler Sovereign
L80154580348 LH Clear Lens
L80154580349 RH Clear Lens



LAMP L803
LUCAS L803 Clear reverse lens without reflectors
L80354582588



REAR LENS L832
For Triumph TR6 side marker lens
L83254579603 RH Red Lens
L83254580156 RH Amber Lens
L83254580154 LH Amber Lens



REAR LENS L832
For Triumph TR6 flasher lens
L83254580329 LH Amber Lens
L83254580330 RH Amber Lens



REAR LENS L832
For Triumph TR6 reverse lens
L83254583840 LH Clear Lens
L83254583841 RH Clear Lens



Pictures above: We carry a large range of the original tooling for the lights of many classic and vintage cars.

LIGHTING

SWITCHES

IGNITION

WIRING

HEATERS & ELECTRIC FANS

ACCESSORIES

BODY HARDWARE

BRAKES & SUSPENSION

CLUTCH KITS

EXHAUSTS

FIXINGS

FUEL SYSTEMS & FILTERS

GAUGES

MIRRORS

POWER STEERING

SEATS & SEAT BELTS

WASHERS & WIPERS

OIL & AIR FILTERS

CARE & STORAGE

OIL, GREASE & FLUIDS

PAINT & ANTI-RUST

TOOLS



'D' LAMP
Stop, tail and numberplate lamp, 12V, 95mm tall x 60mm deep. Chrome
ST51/C
Spare lens for above
524823



'D' LAMP WITH BAR
Stop, tail and numberplate lamp, 12V, 95mm tall x 60mm deep. Chromed with bar
010.049



'D' LAMP WITH BAR
Stop, tail and numberplate lamp, 12V, 95mm tall x 60mm deep. Black with bar
ST51



REAR LAMP/FLASHER & NUMBERPLATE LAMP
In stainless steel and glass. 1930/40s period
010.062
Red/amber lens for above Rear lamp
010.389



RER14 REFLECTOR
RER14 reflector, single stud fixing. **Triumph TR2 to 3a**
RER14



AMBER REFLECTOR
LUCAS Amber Reflector - **573799**
573799



RED REFLECTOR RER24
LUCAS **RER24** Rear Reflector
RER24



REFLECTORS RER22
Red with chrome rim, 89mm x 43mm, 'E' Marked
RER22



BLACK ST38 'PORK PIE' ST38
Popular rear lamps providing a rear lamp, brake lamp and numberplate lamp. Diameter 90mm x 63mm deep. Black
ST38



CHROME ST38 'PORK PIE' ST38/C
Popular rear lamps providing a rear lamp, brake lamp and numberplate lamp. Diameter 90mm x 63mm deep. Chrome
ST38/C



BLACK ST38 'PORK PIE' WITH FLASHER ST38/F
The **ST38** modified to include a new lens, to provide an indicator (flasher). Black
ST38/F



CHROME ST38 'PORK PIE' WITH FLASHER ST38/CF
The **ST38** modified to include a new lens, to provide an indicator (flasher). Chrome
ST38/CF



DIVER'S HELMET REAR LAMP
Shows a 50mm diameter red light to rear, red and clear lenses to side which can be assembled with clear lens either side for the numberplate. Black rubber body with back mounting requires 10mm diameter hole, electrical connection at base. Uses Bulb **LLB381 5/21w**
010.060



SPARE LENSES FOR DIVER'S HELMET REAR LAMP:
Large red 58mm diameter **010.470**
Large amber 58mm diameter* **010.471**
Small side clear 44mm diameter **010.472**
Small side red 44mm diameter **010.473**

* (enables you to convert lamp to indicator). Shown above

REFLECTORS



RED REFLECTOR RER25
With chrome rim, 52mm diameter, central screw fixing. 'E' Marked
LAB701



RED REFLECTOR RER14
With chrome rim, 72mm diameter, central screw fixing. 'E' Marked
LAB705



RED REFLECTOR RER2
In angled black rubber moulding, as fitted to late model **MG TF**. Diameters: reflector 40mm rubber moulding 73mm
010.165

NUMBERPLATE LAMPS



NUMBERPLATE LAMP L534
As fitted to **MGB**, chrome
L534/53705
L534/LENS Glass Lens only



RIGHT HAND PLINTH
For **MGB** Numberplate lamp **L534/53705**
010.298



LEFT HAND PLINTH
For **MGB** Numberplate lamp **L534/53705**
010.299



MOUNTING BRACKET
For **L467** numberplate lamp. Can be mounted on the side or above the numberplate. Bracket arm 125mm long, 38mm wide and the slot will take an 8mm bolt
010.588



L467 NUMBERPLATE LAMP
Chrome numberplate lamp with glass lens, as fitted to many cars through the 50-70s including **MGB, MG Midget, Mini** etc.
L467/56790
L467/R Alternative version with stainless steel body and plastic lens



L467 NUMBERPLATE LAMP BLACK
Black numberplate lamp with glass lens, as fitted to many cars through the 50-70s including **MGB, MG Midget, Mini** etc.
L467/53837



NUMBERPLATE LAMP BLACK
Number Plate Lamp Black Plastic **L467** Copy. Dimensions: Length 110mm, Width 50mm, Height 38mm.
L467/B



COVER ONLY FOR L467 NUMBER PLATE LAMP
Chrome cover for LUCAS **L467** number plate lamp
L467/COVER



NUMBERPLATE LAMP L550
As fitted to **Triumph TR5** and other cars
L550/S



NUMBERPLATE LAMP L766
As fitted to **Triumph TR6** to **CR/CF1 & Stag**
L766/54866



L766 NUMBERPLATE LAMP
L766 Polished chrome finish, Fitted with 2 bulbs to illuminate the numberplate. Base mounted via 2 bolts and includes a rubber gasket.
L766/54632



NUMBER PLATE LENS BASE ASSEMBLY
LUCAS Number Plate Lamp lens Assembly. LUCAS **L860**
L860/56948

LIGHTING

SWITCHES

IGNITION

WIRING

HEATERS & ELECTRIC FANS

ACCESSORIES

BODY HARDWARE

BRAKES & SUSPENSION

CLUTCH KITS

EXHAUSTS

FIXINGS

FUEL SYSTEMS & FILTERS

GAUGES

MIRRORS

POWER STEERING

SEATS & SEAT BELTS

WASHERS & WIPERS

OIL & AIR FILTERS

CARE & STORAGE

OIL, GREASE & FLUIDS

PAINT & ANTI-RUST

TOOLS

LIGHTING

SWITCHES

IGNITION

WIRING

HEATERS & ELECTRIC FANS

ACCESSORIES

BODY HARDWARE

BRAKES & SUSPENSION

CLUTCH KITS

EXHAUSTS

FIXINGS

FUEL SYSTEMS & FILTERS

GAUGES

MIRRORS

POWER STEERING

SEATS & SEAT BELTS

WASHERS & WIPERS

OIL & AIR FILTERS

CARE & STORAGE

OIL, GREASE & FLUIDS

PAINT & ANTI-RUST

TOOLS



REVERSING/NUMBERPLATE LAMP L469
 Reproduction of the Original LUCAS lamp from the 1950s, fits certain British cars such as *Aston Martin, Allard 1952-55, Alvis 1953-55, Lagonda 1954-58, Jaguar XKs, Rover P4 and Jensen 541*
L469/53097



REAR NUMBERPLATE LAMP L705
 LUCAS L705 Rear Number Plate Lamp
L705/53993



DASH LAMP
 For fitting to panel, 1 1/8" diameter. Of the type fitted at the end of the 1920s
010.035



LED POST LIGHT
 12 volt. Body length 28mm, overall length 65mm. If you need a longer one, this can be extended.
010.461
010.462 17mm Extension for post light



MODERN POST LIGHT
 12 volt with LED. Requires 8mm diameter hole in wood or metal dashboard. 12.5mm diameter and 14mm in front of dashboard. Stainless steel
010.057A

LIGHTING

SWITCHES

IGNITION

WIRING

HEATERS & ELECTRIC FANS

ACCESSORIES

BODY HARDWARE

BRAKES & SUSPENSION

CLUTCH KITS

EXHAUSTS

FIXINGS

FUEL SYSTEMS & FILTERS

GAUGES

MIRRORS

POWER STEERING

SEATS & SEAT BELTS

WASHERS & WIPERS

OIL & AIR FILTERS

CARE & STORAGE

OIL, GREASE & FLUIDS

PAINT & ANTI-RUST

TOOLS

INTERIOR LAMPS



INTERIOR LAMP
 Incorporating switch for *MGB, Rover P5 & P5B*. 120 x 32 x 24mm
010.058



SMALL INTERIOR LAMP
 66 x 30 x 25mm. No switch. Installs on flat surface using the two screws supplied at 51mm centres. Could also be used as a numberplate lamp
010.446



GLOVE BOX LAMP LENS
 For *Rolls-Royce Silver Shadow*. Moulded in heat resisting clear plastic using the original tooling
010.164



INTERIOR OR UNDER BONNET LAMP
 Spare lens for L562/56094 Interior or Under Bonnet Lamp
L562/LENS
L562/535156 Chrome plastic rim



INTERIOR LIGHT OR UNDERBONNET LAMP L562
 A quality reproduction of the LUCAS interior light that was also used by *Aston Martin* as an under bonnet lamp
L562/56094



HELLA INTERIOR OR GLOVEBOX LAMP
 Length 90mm, Width 23mm, Height 35mm
010.039



HELLA INTERIOR LAMP
 Hella interior lamp as fitted on *Aston Martin* and *Volvo Amazon*
010.040

MAP READING LAMPS



INTERIOR PLOTLIGHT
 Has a 12V 10 watt halogen bulb which gives a brilliant light for reading pace notes & maps. For mounting under the door seal on the door frame. Pivots to get the light just where you want it. Designed and made by master navigator Don Barrow
091.829



FLEXIBLE MAP READING LAMP
 With switch, screws & stowage clip. 12v, 18" (457mm) long. Light beam comes from the end of the lamp
010.038

WARNING LIGHTS

16mm diameter Warning Lights. Require hole 13mm diameter. 6.4mm Lucar connectors. These warning lights come without a bulb, Order separately **LLB281**



Green
010.033



Green with Indicator Arrow
010.610



Green with 2 Indicator Arrows
010.611



Green with Foglamp symbol
010.612



Red
010.031



Red with Battery symbol
010.615



Red with Brakes symbol
010.616



Red with Foglamp symbol
010.617



Red with Hazard symbol
010.618



Red with Oil symbol
010.619



Red with Seatbelt symbol
010.620

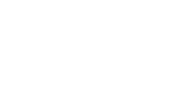

Red with De-mist symbol
010.621



Amber
010.030



Amber with Fan symbol
010.623



Amber with Oil symbol
010.624



Amber with De-mist symbol
010.621



Blue
010.032



Blue with Bulb symbol
010.627



Blue with Headlamp symbol
010.628

More on next page

LIGHTING

SWITCHES

IGNITION

WIRING

HEATERS & ELECTRIC FANS

ACCESSORIES

BODY HARDWARE

BRAKES & SUSPENSION

CLUTCH KITS

EXHAUSTS

FIXINGS

FUEL SYSTEMS & FILTERS

GAUGES

MIRRORS

POWER STEERING

SEATS & SEAT BELTS

WASHERS & WIPERS

OIL & AIR FILTERS

CARE & STORAGE

OIL, GREASE & FLUIDS

PAINT & ANTI-RUST

TOOLS

LUCAS Dash Warning Lamps



LUCAS Amber Dash Warning Lamp **SPB391**
010.041



LUCAS Green Dash Warning Lamp **SPB390**
010.042



LUCAS Red Dash Warning Lamp **SPB389**
010.043



LUCAS Blue Dash Warning Lamp **SPB392**
010.047



LUCAS Red Warning Lamp - **SPB354**
SPB354



LUCAS Green Dash Warning Lamp **SPB355**
SPB355



LUCAS Blue Warning Lamp - **SPB356**
SPB356



LUCAS Amber Warning Lamp **SPB357**
SPB357



WL3 GREEN
Green. As fitted on **MG TD**, also on bikes. 22mm diameter, requires hole size 19mm diameter
38018



WL3 RED
Red. As fitted on **MG TA/TB/TC/TD**. Red, 22mm dia, requires hole size 19mm diameter
38054



WL3 BLUE
Blue. A faithful reproduction of the LUCAS type **WL3** warning lamp found on a multitude of cars and motorcycles, **38081**. 22 mm diameter, requires hole size 19 mm diameter
38081



WL3 AMBER
A faithful reproduction of the LUCAS type **WL3** warning lamp found on a multitude of cars and motorcycles, **38029**. 22 mm diameter, requires hole size 19 mm diameter
38019



WL3 RED
Red. As fitted on **MG TD**, also on bikes. 22mm diameter, requires hole size 19mm diameter
38084



WL3 GREEN
Red. As fitted on **MG TA/TB/TC/TD**. Red, 22mm dia, requires hole size 19mm diameter
38085



WL3 BLUE
Amber. As fitted on **MG TA/TB/TC/TD**. Red, 22mm dia, requires hole size 19mm diameter
38086



Green
010.092



Red
010.093



Blue
010.095



Clear
010.094

29mm diameter Warning Lights. Require hole 19mm diameter. Has a removable diffuser under the lens which can be titled using dry print lettering

8.5mm diameter LED Warning Lights. Require hole 8.2mm diameter. Connect red lead to positive



Green
010.1000



Red
010.1001



Amber
010.1002



Flashing Red
010.1003

16mm diameter LED Warning Lights. Require hole 14mm diameter. Connect red lead to positive



Green
010.583



Red
010.584



Amber
010.587



Blue
010.586

LUCAS **WL13** Warning Lamp. Diameter 25mm. Length 45mm, Requires hole size 20mm.



LUCAS **WL13** warning lamp. Supplied with 3 lenses, Red, Blue, and Green
010.1004

BPF BULBS

FOR BPF HEADLAMPS				
	Volts	Dips	Wattage	Part No.
	6	To the left	30/24 watts	LLB312
	12	To the left	50/40 watts	LLB414
All P36d double contact cap				

FOR 12V BPF FOGLAMPS		FOR 12V BPF FOGLAMPS	
	38w Double Contact Bulb with transverse filament for BPF Foglamps. P36d double contact cap LLB326 (see also Halogen bulbs)		48w Single Contact Bulb with transverse filament for BPF Foglamps. LLB323

On these pages the following definitions apply:

Dips to the left: The normal requirement for Right Hand Drive (RHD), driving on the left hand side of the road as in the UK



Dips to the right: The normal requirement for Left Hand Drive (LHD), driving on the right hand side of the road as in Europe & USA

Bulbs with the same cap number and pins are interchangeable with each other.

Figures within the BA cap number are the cap diameter in mm. Example: BA15s is 15mm diameter

More on next page

HALOGEN UPGRADE FOR BPF HEADLAMPS

	Volts	Wattage	Part No.	
	6	35/35 watts	010.397	
	12	35/35 watts	010.564	
	12	45/40 watts	010.565	
	12	60/55 watts	010.398	
All P36d double contact cap and dip to the left				

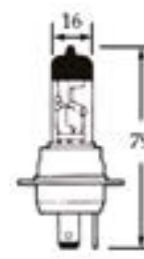

HALOGEN UPGRADE FOR BPF HEADLAMPS

	12v 60/55 watts dips to the left. P36t cap with triple Lucar connectors LLB463
---	--

HALOGEN UPGRADE FOR BPF FOG & SPOTLAMPS

	For Spotlamps 12v 48 watts axial filament, P36s single contact cap LLB185H
--	--

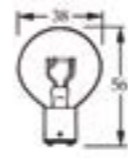

FOR EARLY HEADLAMPS

	Volts	Cap	Wattage	Filament	Part No.	
	12V	Ba 15d	36/36	Double contact cap (left)	LLB171	
	12V	Halogen upgrade 35/35 watts (right)			LLB171/H35	
	6V	Halogen upgrade 25/25 watts			LLB170/H25	
	6V	Halogen upgrade 35/35 watts			LLB170/H35	

FOR EARLY HEADLAMPS OR SPOTLAMPS



	Volts	Size	Cap	Filament	Part No.
	12	BA15s	Single contact cap	36 watts axial filament	LLB002
	12	BA15s	Single contact cap	48 watts axial filament	LLB023
	12	BA15d	Double contact cap	36 watts axial filament	LLB005

BOSCH/ P100 HEADLAMPS OR EARLY SPOTLAMPS

	Volts	Wattage	Part No.	
	Ba20s single contact cap			
	6	36 watts	LLB130	
	12	35 watts	LLB96/A	
	12	45 watts	LLB96	
	Ba20d double contact cap			
	6	35/35 watts	LLB393	
	6	Halogen Upgrade 35/35 watts (right)	LLB393/H35	
	6	45/40 watts.	LLB390	
	12	45/40 watts	LLB396	

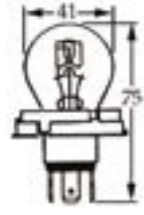

UEC BULBS

FOR UEC HEADLAMPS

	Volts	Wattage	Image	Part No.	
	6	45/40	Left	LLB423	
	12	45/40		LLB410	
	12	75/75		LLB416	
	12	Halogen upgrade 60/55	Right	LLB012	
	12	Halogen off road 100/80	Right	LLB485	

SCREW TYPE BULBS

SCREW TYPE BULBS

	Volts	Wattage	Cap	Part No.	
	6	3 watts	MES E10 Cap (left)	LLB990	
	6	6 watts	MES E10 Cap (left)	LLB101	
	12	1.5 watts	LES E5 Cap (right)	LLB280	
	12	2.2 watts	MES E10 Cap (left)	LLB987	

FOR MARCHAL 12V HEADLAMPS

	Ba21d double contact cap 45/40 watts LLB217
---	--









LIGHTING
SWITCHES
IGNITION
WIRING
HEATERS & ELECTRIC FANS
ACCESSORIES
BODY HARDWARE
BRAKES & SUSPENSION
CLUTCH KITS
EXHAUSTS
FIXINGS
FUEL SYSTEMS & FILTERS
GAUGES
MIRRORS
POWER STEERING
SEATS & SEAT BELTS
WASHERS & WIPERS
OIL & AIR FILTERS
CARE & STORAGE
OIL, GREASE & FLUIDS
PAINT & ANTI-RUST
TOOLS

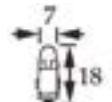
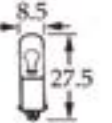
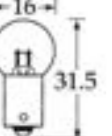
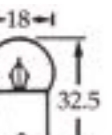
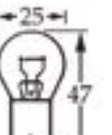
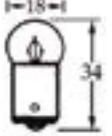
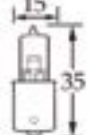



LIGHTING
SWITCHES
IGNITION
WIRING
HEATERS & ELECTRIC FANS
ACCESSORIES
BODY HARDWARE
BRAKES & SUSPENSION
CLUTCH KITS
EXHAUSTS
FIXINGS
FUEL SYSTEMS & FILTERS
GAUGES
MIRRORS
POWER STEERING
SEATS & SEAT BELTS
WASHERS & WIPERS
OIL & AIR FILTERS
CARE & STORAGE
OIL, GREASE & FLUIDS
PAINT & ANTI-RUST
TOOLS

LIGHTING
SWITCHES
IGNITION
WIRING
HEATERS & ELECTRIC FANS
ACCESSORIES
BODY HARDWARE
BRAKES & SUSPENSION
CLUTCH KITS
EXHAUSTS
FIXINGS
FUEL SYSTEMS & FILTERS
GAUGES
MIRRORS
POWER STEERING
SEATS & SEAT BELTS
WASHERS & WIPERS
OIL & AIR FILTERS
CARE & STORAGE
OIL, GREASE & FLUIDS
PAINT & ANTI-RUST
TOOLS





LIGHTING
SWITCHES
IGNITION
WIRING
HEATERS & ELECTRIC FANS
ACCESSORIES
BODY HARDWARE
BRAKES & SUSPENSION
CLUTCH KITS
EXHAUSTS
FIXINGS
FUEL SYSTEMS & FILTERS
GAUGES
MIRRORS
POWER STEERING
SEATS & SEAT BELTS
WASHERS & WIPERS
OIL & AIR FILTERS
CARE & STORAGE
OIL, GREASE & FLUIDS
PAINT & ANTI-RUST
TOOLS

BA7S SINGLE CONTACT CAP			
	Volts	Watts	Part No.
	12	2	LLB281
BA9S SINGLE CONTACT CAP			
	Volts	Watts	Part No.
	6	4	LLB293
	12	4	*LLB233
	*LED version of above:		
	12	4	LED233W
	Volts	Watts	Part No.
	6	3	LLB641
	12	2.2	LLB643
	12	5	LLB989
BA15S SINGLE CONTACT CAP			
	Volts	Watts	Part No.
	6	5	LLB205
	6	10	LLB244
	12	5	*LLB207
	*LED version of above:		
	12	5	LED207W
	12	10	LLB245
	6	18	LLB316
	6	21	LLB317
	Volts	Watts	Part No.
	12	21 Amber	LLB343
	12	21	*LLB382
	*LED versions of above:		
	12	White	LED382W
	12	Red	LED382R
	12	Amber	LED382Y
	Volts	Watts	Part No.
	12	21	LLB382/S
	Volts	Watts	Part No.
	12	21	LLB264
	Halogen upgrade bulb, enables you to upgrade your brake lights if they use the Ba15s cap		

BA15D DOUBLE CONTACT CAP			
	Volts	Watts	Part No.
	6	5/21	LLB384/S
	12	5/21	LLB380/S
	Volts	Watts	Part No.
	6	5	LLB206
	6	10	LLB244D
	12	5	LLB209
	Volts	Watts	Part No.
	6	18	LLB319
	12	21	LLB335
BA15D DOUBLE CONTACT CAP PARALLEL PIN			
	Volts	Watts	Part No.
	12	5/21	LLB381
BAY15D DOUBLE CONTACT CAP OFFSET PIN			
	Volts	Watts	Part No.
	6	5/21	LLB384
	12	5/21	*LLB380
	*LED version of above:		
	12	White	LED380W
	12	5/21 Red	*LLB380R
	*LED version of above:		
	12	Red	LED380R
	12	Amber	LLB380/A
	*LEDs (Light Emitting Diode) are semi-conductor devices that offer advantages over conventional bulbs of increased brightness, lower energy consumption and longer life. LEDs are suitable for negative earth only. LED382W shown left. (By a quirk of the law LEDs are not legal on the road unless your vehicle was originally homologated with them. Therefore we sell LEDs on the basis that they are for off road or track use only) , Sold in pairs		

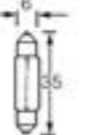
			
W2X4.6D FITTING	W2.1X9.5D FITTING	W2.1X9.5D FITTING	W2.1X9.5D FITTING
*LED version 12V 1.2 watts LED286W	6V 3 watts LLB500	12V 2.2 watts As used in Smiths gauges LLB510	12V 21 watts LLB921A
12V 2 watts LLB924	12V 5 watts LLB501	*LEDs (Light Emitting Diode) are semi-conductor devices that offer advantages over conventional bulbs of increased brightness, lower energy consumption and longer life. LED286W shown. (By a quirk of the law LEDs are not legal on the road unless your vehicle was originally homologated with them. Therefore we sell LEDs on the basis that they are for off road or track use only)	
	*LED version of above: 12V White LED501W		
	*LED version of above: 12V Blue LED501B		

FESTOON BULBS

				
12V 3 watts LLB256A	12V 3 watts LLB256	6V 10 watts LLB1059	12V 5 watts LLB239	6V 18 watts LLB1061
		12V 10 watts LLB272		12V 15 watts LLB267
				12V 21 watts LLB273

AMERICAN BULBS

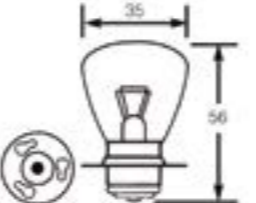
AMERICAN PRE FOCUS BULBS				
	Volts	Wattage	Filament	Part No.
	12	45/40w	Double filament	LLB669

- LIGHTING
- SWITCHES
- IGNITION
- WIRING
- HEATERS & ELECTRIC FANS
- ACCESSORIES
- BODY HARDWARE
- BRAKES & SUSPENSION
- CLUTCH KITS
- EXHAUSTS
- FIXINGS
- FUEL SYSTEMS & FILTERS
- GAUGES
- MIRRORS
- POWER STEERING
- SEATS & SEAT BELTS
- WASHERS & WIPERS
- OIL & AIR FILTERS
- CARE & STORAGE
- OIL, GREASE & FLUIDS
- PAINT & ANTI-RUST
- TOOLS

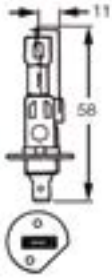
H1 HALOGEN BULBS FOR HEADLAMPS AND SPOTLAMPS			
P14.5s cap with single Lucar connector			
	Volts	Watts	Part No.
	6	55	LLB465
	12	55	LLB448
	Suitable for off road use only:		
	12	130	LLB487

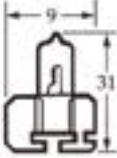
H2 HALOGEN BULB AS USED IN SOME CIBIE LAMPS			
X511 fitting			
	Volts	Watts	Part No.
	12	55	LLB479
	Suitable for off road use only:		
12	100	LLB482	

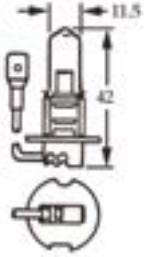
H3 HALOGEN BULB FOR HEADLAMPS AND SPOTLAMPS			
PK22s cap with single lead			
	Volts	Watts	Part No.
	6	55	LLB455
	12	55	LLB453
	Suitable for off road use only:		
12	130	LLB489	

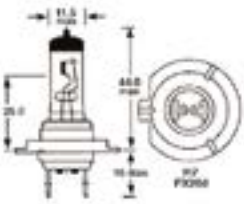
H7 12V 55W	
Single beam Halogen Bulb as used in many modern cars	
	Part No.
	LLB499

H4 HALOGEN BULB FOR HEADLAMPS			
P43t cap with triple Lucar connectors			
	Volts	Watts	Part No.
	6	60/55	LLB476/6V
	12	35/35	LLB472B
	12	60/55	LLB472
	Suitable for off road use only:		
	12	100/88	LLB484
12	130/90	LLB477	
12	160/100	LLB486	
FOUR SEASONS			
Fits all headlamps using the H4 type bulb. It is rated at 60/55 watts, but is specially designed for adverse conditions of mist, fog and snow			
12	60/55	LLX472FS	

NIGHT BREAKER UNLIMITED				
	These bulbs fit all lamps using Halogen bulbs. The maker, Osram, says they give up to 110% more light with up to 20% whiter light reaching up to 35/40 metres further down the road than a standard bulb. Supplied as a pair in a neat carrying case that makes it suitable for taking as spares in the car, as demanded by some countries			
	Type	Volts	Watts	Part No.
	H1	12	55	LLY448
	H4	12	60/55	LLY472
	H7	12	55	LLY499



Halogen bulbs are now available to upgrade your lighting on earlier lamps. We have listed these under the various headings: BPF, UEC etc.